

**FIRAT**

**FIRAT**

Türkoba Köyü P.K. 12  
34907 Büyükçekmece İstanbul / TURKEY  
T: +90 (212) 866 41 41 - 866 42 42  
F: +90 (212) 859 04 00 - 859 05 00  
[www.firat.com](http://www.firat.com)  
[fiat@fiat.com](mailto:fiat@fiat.com)  
[info@fiat.com](mailto:info@fiat.com)

**FKS SEWAGE SYSTEMS**



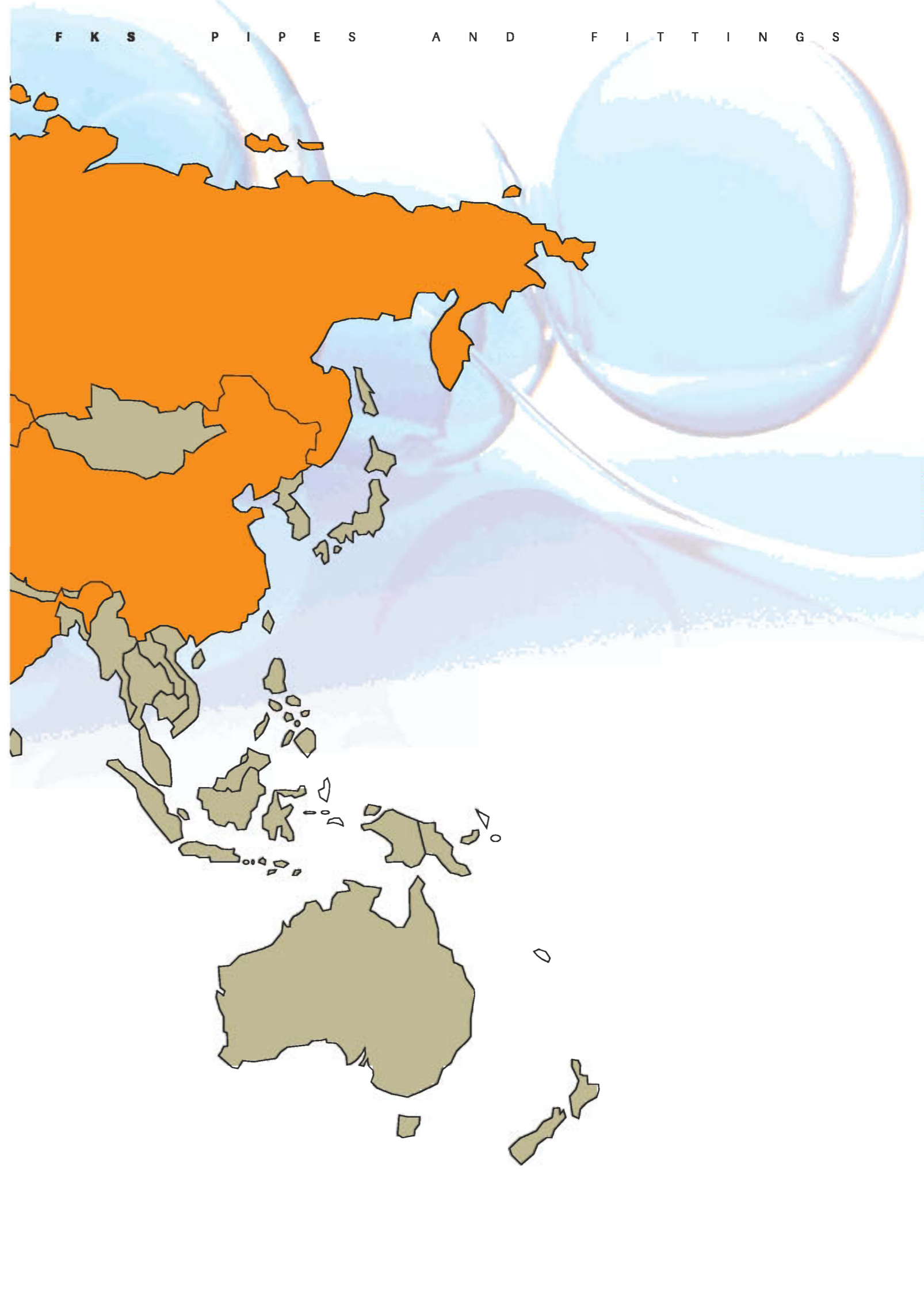

**CONTENTS**

Introduction	<b>02</b>
Raw material	<b>06</b>
Our Quality Understanding	<b>08</b>
Corporate Training	<b>12</b>
Eco-Friendly FIRAT	<b>13</b>
General Information	<b>14</b>
General Specifications of FKS Pipes	<b>16</b>
Fluidity in FKS Pipes	<b>18</b>
Flexibility of FKS Pipes	<b>19</b>
Strength of FKS Pipes	<b>20</b>
Flexibility of FKS Pipes Electrical Insulation	<b>21</b>
Chemical Resistance of FKS Pipes	<b>22</b>
Production Methods of FKS Pipes	<b>24</b>
PR Series FKS Pipes	<b>25</b>
SQ Series FKS Pipes	<b>28</b>
VW Series FKS Pipes	<b>33</b>
FKS Pipe and Fittings Welding Methods	<b>36</b>
Electro-fusion Welding Method	<b>36</b>
Butt Fusion Method	<b>39</b>
Extrusion Welding Method	<b>41</b>
Gasket Connection Method	<b>44</b>
Flange Connection Method	<b>45</b>
Sewage Application Methods	<b>46</b>
Sewage Application Method of FKS Pipes	<b>46</b>
Trench Excavation	<b>47</b>
Trench Filling Material	<b>48</b>
Bedding the Pipes	<b>48</b>
Filling and Compacting	<b>49</b>
Top Filling	<b>50</b>
FKS Pipes Relining Application Method	<b>50</b>
Solid Waste Projects Application Method with FKS Pipes	<b>51</b>
FKS Manhole and Application Method	<b>52</b>
Other Applications of FKS Pipes	<b>52</b>
FKS Pipe and Fittings	<b>53</b>
Elbow, Y-Branch and Reducers	<b>53</b>
Manhole, Chimney and Tanks	<b>56</b>
Special Fittings	<b>60</b>
FKS Pipe Storage and Shipment Methods	<b>62</b>
FKS Pipe Calculation Methods	<b>64</b>
Points to be Considered Carefully While Installing FKS Pipes	<b>70</b>
FKS Procurement Tender Specifications and Comparison Table	<b>72</b>
FKS Pipe and Manhole Information Request Form	<b>75</b>
FKS Manhole and Tank Information Request Form	<b>77</b>
FKS Pipe Article Numbers	<b>79</b>
FIRAT Export Map	<b>82</b>



## FIRAT

FIRAT was established in 1972 to make production in the field of plastic construction materials. FIRAT, who has always followed its principle of "Quality Production at All Times" and "quality product diversity", has managed to become "the leader of sector" as well as "the export leader of sector" as a result of the serious enterprises.

With its plastic-based products, FIRAT makes production for various sectors like construction, agriculture, automotive, medical and white goods. It carries out its manufacturing process for these sectors in its factories of 650.000 m<sup>2</sup> in total in Istanbul-Buyukcekmece and Ankara-Sincan. FIRAT owns one of the five biggest manufacturing complexes of Europe.

According to the survey of Istanbul Chamber of Commerce in 2009, FIRAT ranks as the 53rd amongst the 500 big industrial establishments of Turkey. FIRAT ranks as the 48th one in the private sector ranking. According to the Corporate Tax Ranking of T.R. Ministry of Finance Revenue Administration Department in 2009, FIRAT is the 51th amongst the top tax payer companies of Turkey. FIRAT ranks as the 144th in list of "Leader Exporting Manufacturers of Turkey in 2009", according to Turkey Exporters Committee and is the leader exporter in its sector.



As of the end of 2009, the number of personnel working under FIRAT structure is 1500. Believing in the understanding of "The most valuable factor is human", FIRAT has been constantly arranging in service trainings both for the personnel to increase their experience at work and their corporate knowledge.

### **Product Diversity and Groups**

Product diversity of FIRAT is over 4500. For our customers to obtain the optimum benefit and satisfaction out of these products, FIRAT makes production as integrated (completing one another) systems.

Thousands of FIRAT products like PVC Door and Window Profiles, PVC Rain Gutters and Fittings, PVC Drinking Water and Waste Water Pipes. PVC Hose Groups, Rubber and PE Based Hoses, PPRC Sanitary Installation Pipes and Fittings, HDPE Pipes, EF Fittings, PE Fittings, PE 80 Natural gas Pipes, Drainage Pipes, Telecommunication Cable Protection Pipes, EPDM Sealing Manufacturing, TPE Sealing Manufacturing, Metal Injection Production (hinge and window connection components), PEX Mobile System and Floor Heating Pipes, Pex Al Pex Pipe and PPSU Fittings, Drip Watering Pipes, Medical Products render service in numerous parts of Turkey and the world.

FIRAT Company - which has broken the world record by producing PE100 pipes of 1200 mm, 110 mm wall thickness and enduring up to 16 bars in the "Bosphorus Project", and has carried drinking water to the European side of Istanbul - now has performed a first in Turkey and has produced pipes of 500 meters length. These pipes are going to be used in a "purification of the sea - water project" in Libya. They were produced as 1400 mm PE100 pipes, withstanding 6,4 bars pressure with a wall thickness of 55 mm's. By producing these 6 pieces of 500 metersone - piece pipes, FIRAT is a pioneer in continuous pipe production for monolines for the first time in Turkey.

FIRAT manufactures FKS canalisation pipe, the testable operating life of which is 100 years. These pipes which can be manufactured up to 2400 mm diameter from HDPE (high density polyethylene) raw material are resistant against ground motion, gnawing animals, plant roots and chemical wastes. FKS pipes are manufactured with German company Krah technology and licence.



Triplex pipes again manufactured in FIRAT facilities are used in outdoor installations and grounds as well as domestic connections, predominantly in sewer line, rain water drainage lines, industrial waste water installations, water conveying pipes and drainage systems.

Triplex pipe has big advantages like high flow performance, external load resistance, long operating life, transport and storage convenience, its becoming economic, endurance against chemical substances, price and maintenance convenience, imperviousness and filter-free operation choice.

FIRAT is the single firm in the world's plastic sector manufacturing all of the PVC window and door system components excluding glass and screw. Since full harmony of PVC window and door is only possible with integrated manufacturing process; FIRAT manufactures PVC Profile, EPDM seal, TPE seal, reinforcement steel and whole range of metal accessories in integrated manner within its facilities.

FIRAT is capable of conducting welding, heavy rain and wind resistance, blow and milled blow resistance, compression, shear and break-off strength ring rigidity (strength of FKS and Triplex pipes against soil load) tests in its the state-of-the-art test and analysis laboratories. Our products are offered to the service of our customers only after they are confirmed by the Quality Assurance Group related to their conformity to production, sale and outlet.

Following completion of all quality control tests, FIRAT products are offered to the market with "FIRAT Quality Assurance Confirmation". FIRAT holds international quality certificates such as RAL GOST, SKZ, EMI, DVGW, TSE as well as ISO 14001, OHSAS 18001, ISO 10002 and ISO 9001 system certificates.

FIRAT products achieved satisfaction of customers in more than 60 countries and deserved a distinguished place in the markets.



To develop, grow, struggle to achieve perfection through advanced technology and utilize all its resources in order to ensure long lasting customer satisfaction are the objectives of FIRAT.

Thanks to reliable, strong, easily accessible and easy-to-use products and perfect aftersale support, FIRAT achieves its target of perfection.

**FIRAT** Administration Building



# Raw Material

## Polyethylene

Polyethylene is a thermoplastic which is used in a wide range of products. It takes its name from ethylene in monomer state. Polyethylene is produced from ethylene. It's short name is generally known as PE in the plastic industry. Ethylene molecule  $C_2H_4$  is in fact is formed by two  $CH_2$  particles bound with double bond.  $(CH_2=CH_2)$  Polyethylene is manufactured through polymerization of ethylene. Polymerization is a reaction starting off with monomer units and resulting in polymer units.

## HDPE

HDPE is a material with high density polyethylene, derived from petroleum. It is the abbreviation of High Density Polyethylene. In the industry and manufacturing sector, generally it's abbreviation is used.

## Raw Material Tests

- Density Test
- Melt Flow Rate Test
- Elongation at break Test
- Impact Resistance Test
- Viscosity and K Number Test
- Particle Size Distribution Test
- Moisture Determination Test

### Rawmaterial and Quality Tests\*



Viscosity and K Number Test



Particle Size Distribution Test



Moisture Test



**Specifications**

The High Density class of polyethylene is called HDPE. HDPE has a very high resistance against water and chemical substances. The mechanical properties of HDPE is very good, and especially it has high impact and tensile strength. It is a material compatible for various forming methods such as injection, extrusion, powder coating, filming, and rotational molding.

**Application Areas**

Having a wide range of application area, HDPE can be used manufacturing pressurized and non-pressurized pipes, gas distribution systems, electrical and electronic equipment. Since it is highly resistant to water, HDPE is also used in manufacturing boats, warehouses and buoys.

\*FRAT employs state-of-the-art quality, control and test laboratories in the sector.



Impact Resistance Test



Density Test



Melt Flow Rate Test

## Our Understanding of Quality

Quality Control Process implemented in FIRAT laboratories consists of three phases:

1. Input Quality Control
2. Process Quality Control
3. Output-Final Quality Control

### **Input Quality Control**

All types of raw materials and auxiliary materials from our suppliers are subjected to Input Quality Control tests according to the quality-production standards set out by FIRAT. Samples randomly chosen from each lot of raw materials and auxiliary materials supplied in lots by our suppliers have to pass through Appearance Marking Compliance, Physical Compliance, Chemical Compliance and Functional Compliance tests in GKK Laboratories and obtain “**Suitable for Production**” approval.

### **Process Quality Control**

In the production process implemented with raw materials and auxiliary materials bearing “Suitable for Production” approval, samples taken on production lines during or soon after production are passed through Process Quality Control tests in FIRAT laboratories determined by national (TSE) and international (DVGW, SKZ, ASTM, ISO etc.) standard institutions and recorded regularly. Main Process Quality Control tests are as follows:

- Blow Strength Test
- Impact Test (strength against external impacts)
- Hydrostatic Pressure Test (for products to operate in pressurized lines)
- Longitudinal Variation (resistance against heat)
- Density Test
- Homogeneity Test
- Melt Flow Index Test

### **Quality Test \***

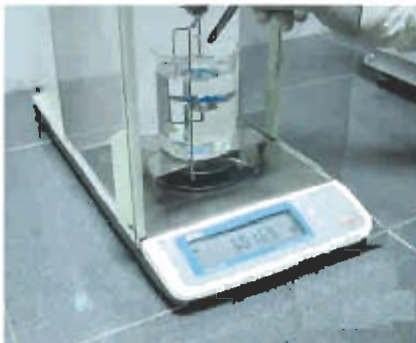

Density Test



Melt Flow Rate Test



Homogeneity Test

At the phase of Process Quality Control; diameter, thickness and ovality measurements are conducted by ultrasonic measurement devices on all production lines in fully automated manner simultaneously with the production process and faulty production is not allowed upon activation of sound and light warning system under out of standard cases. Our products have to pass through all tests conducted in accordance with the control frequency and numbers set out in the standards and obtain **"Suitable for Sale"** approval.

### Output-Final Quality Control

Our products which obtained "Suitable for Sale" approval also have to get **"Suitable for Output"** approval passing through Packaging Compliance, Pack Compliance, Description and Label Compliance checks soon after automatic packaging and wrapping processes.

In addition to the quality control tests conducted in FIRAT laboratories, all our products are sampled from our production lines regularly twice a year and subjected to quality and sanitary compliance tests by international test and certification institutions such as DVGW, SKZ, GOST.

Our products which passed through all these tests and met the required quality conditions are offered to our customers.

\*FIRAT has the state-of-art quality, control and test laboratory in the sector.



Impact Resistance Test



Change in Length



Pressure Test

## Our Understanding of Quality

### **FKS Pipe Production and Quality Guarantee**

Produced from HDPE and PP materials, FKS pipes are at a high quality level. Starting from the raw material input, at every stage of production, all tests are conducted as required by related standards.

Test results are monitored continuously and during deployment stage the welding processes are carried out by both Firat welding team and applicators. These are monitored and records are kept.

Successfully passing the tests required by TS 12132, DIN 16961 norms, FKS pipes have a minimum useful life of 50 years.

### **FKS Pipe Tests and Standards**

FKS Pipe and Pipe fittings are produced in accordance with TS 12132, DIN 16961-1 and DIN 16961-2 norms.

Standards which FKS pipes are monitored and tested according to, starting from raw material and during production and deployment stages:

#### **Raw material Tests and Standards**

Density Test	ISO 1183
Melt Flow Rate Test	ISO 1133

#### **Product Tests and Standards**

Product Standard	TS 12132 DIN 16961-1 DIN 16961-2
------------------	--

Tensile Strength Properties Test  
Color Test  
Ring Rigidity Test  
Tensile Strength Properties Test  
Decohesive Test

#### **Application Tests and Standards**

Water Tightness Test	DIN 1610
Welding Test	DVS 2203
Deformation Test	ATV A 127
Back-fill Compacting Test	ATV A 127

### Our Quality Certificates

FKS Pipes and Fittings have quality certifications that are recognized nationally, internationally and reports issued by third party inspection companies.

- TSE - Turkish Standards Institution (Turkey) 
- GOST (Ukraine) 
- EMI (Hungary) 
- ZIK (Croatia) 



# Corporate Training

Relying on the understanding of **“Human comes first”**, FIRAT invests in human. FIRAT provides its employees with miscellaneous regular intra-company training programs and offers them opportunities to join necessary training, seminar and congress events both within the country and abroad for the purpose of enhancing both their own corporate know-how and business performance.

FIRAT is the leading organization of its sector also in the area of corporate training through clearly and precisely conveying targeted results to its employees, ensuring its employees to enjoy and efficiently implement their assignments and become more participative in the processes, offering them all types of business, training and organization facilities and acting as a **“team”** with all its employees.

Primarily emphasizing the fact of knowledge-based progress in its training programs, FIRAT adopted the principles of utilizing knowledge and technology in its production processes and aftersale services through researcher and problem-solving, result-oriented employees and ensuring continuous customer satisfaction through regular personnel and dealer training programs.



ISO standard preparation meeting of FIRAT, Brussels-Belgium



# Environment-friendly FIRAT

Producing by the use of “**Environmental Friendly Production Technologies**” since its foundation, FIRAT proves its sensitivity toward environmental health through its **Environmental Management System** established in 2002 and considers this area as a “**Window of Management**”.

Upon obtaining TS EN ISO 14001 2004 “**Environment Management System**” certificate from SGS in 2003, FIRAT had its sensitivity toward environmental health confirmed in national and international setting.

FIRAT not only retains its established environmental consciousness within its organization but also transforms this consciousness into an environmental policy and shares it with its neighbors, suppliers and customers. Especially during domestic and foreign seminars held for its end-users, FIRAT shares its efforts made toward environmental problems and importance that should be attached to the environmental health primarily with its business partners.

95% of the products of FIRAT consists of re-cycled, re-processable materials. It sends its non-household wastes and non-recyclable waste products to “**Disposal Facilities**” licensed by the Rep. of Turkey, Ministry of Environment and Forests and implements recycling process in these facilities.

**Environment Management Programs and Projects oriented to Environmental Health Protection** drawn up by the **Environmental Group** consisting of our environmental engineers are being realized within FIRAT organization.

Committing its compliance with all national and international **Environmental Legislative Directives** and **Environmental Regulations**, FIRAT fulfills all its legal liabilities and declares statutory assessment reports to the relevant Ministry.

FIRAT, awarded by ISO (Istanbul Chamber of Industry) with “**Environment Incentive Reward**” with its environmental project drawn up in 2006, always gives precedence to the importance of environmental health and shows necessary sensitivity in all its investments.



## General Information

FKS Pipes, which can be produced with internal diameters up to 3.600 mm and with different properties are manufactured from HDPE or PP raw material according to the application purposes.

Muff sections of FKS pipes are reinforced with electro-fusion welding system. Upon request seal-type, muff-type or butt-welding compatible pipes, and also, special applications such as tower bunkers, tank and manholes can be produced.

Since HDPE has certificates for health conformity, it is used in FKS production, and it can be used successfully in transportation or storage of any kind of food.

Enabling the control inside a pipe with a video camera, thanks to its interior surfaces having the light colors reflecting the light produced by co-extrusion technology, FKS pipes are produced with special film coating using co-extrusion technology which also enables to discharge the static electricity for critical projects.





Joining FKS pipes in very short times with electro-fusion welding method, narrow excavation area, minimum workmanship and shorter time of installation provides great advantages for applicators. Having a testable useful life of 100 years, FKS pipes are guaranteed by FIRAT against manufacturing defects if they are installed in accordance with ATV A 127 norm. FKS pipes provide service for a minimum period of 50 years just like they are brand new.

Since FKS pipes are manufactured from HDPE and have high impact resistances they highly withstand earth movements, rodents, plant roots and aggressive liquids. Since they are produced from UV-stabilizer HDPE, they show great resistance against sun rays. This property also protects them against temperature changes.

Thanks to its glasslike smooth internal surface, their flow rates are very high and they do not cause sedimentation in any way.

Due to their high resistance against chemicals pipe surfaces are not subjected to corrosion and they have high resistance. Since they are bonded with electro-fusion welding method, they provide ultimate impermeability and high safety.

Since their impact resistance is very high and do not cause any loss during either transportation or storage and they can be stacked telescopically and on top of each other, FKS pipes provide great advantages during shipping and at the storage area.



# **General Specifications**

---

## **of FIRAT FKS Pipes**

### **Raw material Specifications**

FKS pipes are generally produced from high density polyethylene (HDPE) raw material. PP raw material can be preferred for pipes which will be used for fluids having high temperatures. Both raw materials are preferred in pipe production because of their ease of processing, low density and being completely hygienic.

### **The advantages offered by HDPE and PP used in FKS production;**

- Easy transportation thanks to its lightweight.
- High resistance against chemicals.
- Flexibility and excellent impact strength.
- Highly durable against adverse environmental conditions
- HDPE is resistant to UV rays.
- Easy and sturdy welding capability.
- High strength against abra No sedimentation thanks to smooth surface.
- High flow rate and low pressure loss.
- Not affected from frost in cold climates.
- HDPE and PP can be used up to 60°C and 95°C respectively in a safe manner.
- No corrosion.
- Withstands rodents and plant roots.

**FKS Pipe Raw Material Polymer Specifications**

Specification	Conditions	Method	Unit	Typical Values
Density	23°C	ISO 1183	gr / cm <sup>3</sup>	≥ 0,940
Melt Flow Rate	190°C / 5 kg	ISO 1133	gr / 10 dk.	0,4 - 1,3

**FKS Pipe Raw material Mechanical Specifications**

Specification	Conditions	Method	Unit	Typical Values
Flexibility Module**	Short Term	ISO 178	MPpa	≥ 750
Thermal Expansion**	-	ASTM D 696	1 / K <sup>-1</sup>	1,8 10 <sup>-4</sup>

**FKS Pipe Performance Specifications**

Specification	Conditions	Method	Unit	Typical Values
Ring Stiffness	23°C / max %3	TS 12132 DIN 16961	kN / m <sup>3</sup>	≥ 2-125*
No Leakage	0,5 bar / 15 min	TS 12132 DIN 16961	-	No leakage

\*According to customer's request \*\* Type tests are conducted upon customer's request .



# General Specifications of FIRAT FKS Pipes

## Fluidity in FKS Pipes

Smooth glass-like internal surface of FKS pipes give the pipe high fluidity rate. This feature prevents sedimentation inside the pipes and it also offers greater energy savings by using pumps at lower power compared to other pipes, especially in pressurized lines.

The most significant problem experienced today with traditional pipe systems used for discharging waste water is sedimentation inside pipes formed by materials such as sand and pebbles. These cause clogging inside the piping system in time and as well as abrasion of piping due to friction. The most significant problem is that these sedimentations in Sewage systems connected to treatment facilities penetrate in treatment facilities clogging the system and causing malfunctions and increasing operational cost greatly. On the other hand, ground water leaking into pipes utilizes the pipe capacity unnecessarily and turns out to be the most significant factor increasing the operating cost of treatment.

Especially, in the lines installed in seashores, salt water intruding the pipes both decreases the useful life of mechanical equipments of the treatment system and kills the bacteria used in biological treatments, resulting in complete disablement of the treatment system. Since roughness coefficient of the FKS pipes is very low, it definitely avoids sedimentation and since parts are joined with electro-fusion welding method which provides ultimate tightness, it does not allow intrusion of any foreign material into the pipe.

### Kb Values of Various Pipes

Pipe Type	Kb Value
New steel pipes	0.01 - 0.1
New ductile font pipe	0.0001 - 1
Bitumen ductile and bitumen concrete	0.03 - 0.2
General plastic pipes	0.01 - 0.1
HDPE pipes	0.007 - 0.015
New concrete pipe	1.0 - 2
Baked clay pipe	0.1 - 1
Old worn-out pipes	2



## Flexibility of FKS Pipes

The raw material of FKS pipes has a high elasticity modulus. Therefore, FKS pipes are never affected by earth movements thanks to their impact absorption properties and flexibility.

Pipe systems installed underground are subjected to different and varying loads, impacts during their useful life. Pipelines which are installed with conventional materials, get worn-out in a short time due to traffic loads increasing in parallel with the enhancing technology as well as earthquakes due to geographical location of our country. Especially pipes made up of rigid materials have to absorb loads through one point at the base. Such kinds of pipes easily break since they are compressed between two points against sudden loads applied on them and are not able to flex. Due to these reasons, the most common damages experienced in conventional pipe systems are cracking, collapsing, breaking, plant roots entering and fungal developments.



FKS pipes distribute all loads homogenously around the pipe to avoid compression between two opposite points thanks to their flexible structure. FKS pipes subjected to sudden loads flex from top towards inside and distribute the incoming load towards pipe base and sides and function like a impact absorber damper and when the load on them is removed they flex and restore their previous condition.

**Flexible Pipes**

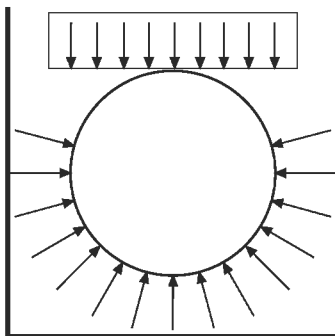

**Rigid Pipes**

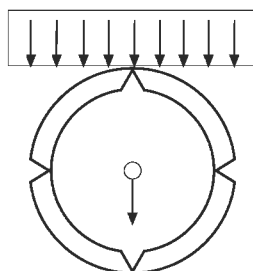
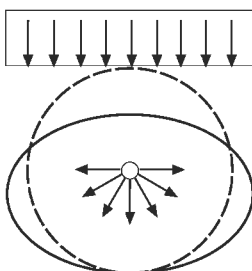
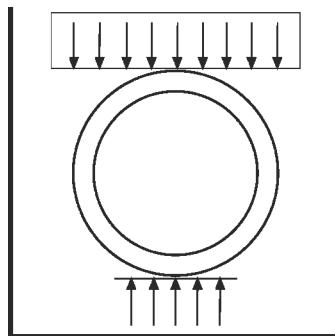

# General Specifications of FIRAT FKS Pipes



## Strength of FKS Pipes

Another feature of FKS pipes is higher lengthwise elongation coefficient compared to other classical pipes. Particularly, externally profiled FKS pipes are capable of elongating at 4 times than their normal length without breaking. Thanks to this feature, they maintain problem-free operation of the system even in case of a landslide. FKS pipes have high strength against any kind of impact, load and ground movements. Since FKS pipes are designed in bearing extensive safety coefficients and risk factors in mind, they will provide service for extended years by preserving their strength values even against heavy loads that they will be subjected due to advancing technology in the future.

When comparing HDPE pipes with pipes manufactured from traditional materials, we shall consider the damage assessment results obtained after 1995 Kobe/Japan, 1999 Armenia and Colombia earthquakes as good examples showing their strengths against earth movements.

### Kobe / Japan 1995\*

Pipe Material	Steel	Cast Iron	HDPE
Tested pipeline (m.)	21.338 m.	12.204 m.	1.458m.
Identified number of hazards	25.821 ad.	630 ad.	0
Number of damage as per km	1,21 ad.	52 ad.	0

### Armenia / Colombia 1999\*\*

Pipe Material	Asbestos	Steel	Cast Iron	HDPE
Tested pipeline (m.)	221.957	3.810	1.030	115.182
Identified rate of hazards	% 71.70	% 0.70	% 0.03	% 0.00
Number of damage as per km	1.43	0.82	1.29	0

As it is seen, since no damage occurred on HDPE pipes in the earthquakes, now all new lines are made by using HDPE pipes. It is also undisputed to use HDPE pipes in infrastructure systems installed by expending high costs in our country under treat of active faultlines.

Source: Damage of Gas Facilities By Great Hanshin Earth Quake restoration Process  
Shojiro Oka Central Office, distribution.  
Department Osaka GAS. Co Ltd.

## Electrical Insulation

Electrical insulation and grounding is required in the system for safety in sensitive and critical projects where FKS pipes are used for methane discharge, methane chimneys, solid waste water drainage, conveying light combustible gases and combustible powders. In such sensitive projects, necessary safety precautions will be taken by coating the internal surfaces of FKS pipes produced with co-extrusion technology with PE-el material and carrying out insulation works required by GUV 17.4 and DIN / IEC 60093 – 60167 as well as grounding the static electricity of the pipe. In such projects, it will be useful to contact with our technical department before application.



## Easy to Apply and Loss-Free Work

FKS pipes are produced in 6 m lengths as standard. Depending on the project specifications, it is possible to produce specific lengths down to 1 m. as well as any kind of auxiliary fittings for the system. Due to the nature of raw material used in the production all parts of the system are far lighter, easier to carry and store compared to conventional traditional materials. Since all materials used in the FKS pipe system is unbreakable, crack-proof and high in impact strength, no construction site and transportation loss occurs.

Since pipe and fittings are fixed with electro-fusion welding, they ensure ultimate tightness and also since the welding process is completed in a short time such as a maximum of 30 minutes, maximal time and labor savings are achieved during application phase. With this method it is possible to lay several times more FKS pipes than traditional pipes in the same timeframe. Since trench excavations for laying FKS pipes will be narrower and gravity flow slopes are lower, it will be possible to ensure considerably amount of savings from excavations and filling.



# General Specifications

## of FIRAT FKS Pipes

### The Resisatance of FKS Pipes and Fittings to Chemical Substanced

#### The Resisatance of FKS Pipes and Fittings against Chemical Substanced

Material	Concentrationon %	T (°C)	Durability
Adipic Acid	sat.sol % 1.4	20/60	R
Allyl Alcohol	ts-s	20/60	R
Aluminium Hydroxide	susp	20/60	R
Ammonia, dry gas	ts-g	20/60	R
Ammonia, diluted	sat.sol	20/60	R
Ammonia, liquid	ts-s	20/60	R
Ammonium Chloride	sat.sol	20/60	R
Ammonium Sulphate	sat.sol	20/60	R
Aniline	sat.sol	20/60	NR
Acetic Acid	50	20/60	R
Acetic Acid, freezes	> 96	20/60	R/LR
Acetone	ts-s	20/60	LR
Copper (II) Sulphate	sat.sol	20/60	R
Benzene	ts-s	20/60	LR
Gasoline (fuel)	o.sol	20/60	R/LR
Beer	o.sol	20/60	R
Vegatable Oils	ts-s	20/60	
Butane, gas	ts-g	20/60	R
Mercury	ts-s	20/60	R
Iron (II) and (III) Chloride	sat.sol	20/60	R
Etanol	40	20/60	R/LR
Ethylene Glycol	ts-s	20/60	R
Phenol	sol	20/60	R
Formaldehyde	Up to 40	20/60	R
Glycerin	ts-s	20/60	R
Air	ts-g	20/60	R
Hydrogen	ts-g	20/60	R
Hydrogen Peroxyde	Up to 30	20/60	R
Hydrochloric Acid	Up to 30	20/60	R
Urine		20/60	R
Iodine (in Alcohol)	o.sol	20/60	NR
Calcium Carbonate	susp	20/60	R
Calcium Chloride	sat.sol	20/60	R
Carbon Dioxide Moisted Gas	ts-g	20/60	R
Carbon Monoxide, gas	ts-g	20/60	R
Carbon Tetrachloride	ts-s	20/60	LR/NR
Chlorine, dry gas	ts-g	20/60	LR/NR
Chloric water	sat.sol	20/60	LR/NR
Chloroform	ts-s	20/60	NR
Lead Acetate	sat.sol	20/60	R



**The Resistance of FKS Pipes and Fittings against Chemical Substances**

Material	Concentration %	T (°C)	Durability
Sulphur Dioxide, dry gas		20/60	R
Methyl Alcohol	ts-s	20/60	R
Nitric Acid	25	20/60	R
with Fumed Nitrogen Oxide		20/60	NR
Oxigene, gas	ts-g	20/60	R/LR
Potassium Hydroxide	sol	20/60	R
Cyclohexenone	ts-s	20/60	R
Sodium Bicarbonate	sat.sol	20/60	R
Vinegar	o.sol	20/60	R
Sodium Hydroxide	sol	20/60	R
Sodium Carbonate	sat.sol	20/60	R
Sodium Chloride	sat.sol	20/60	R
Sodium Sulphate	sat.sol	20/60	R
Water Distilled Sea		20/60	R
Water, Usage, Mineral (mine)	o.sol	20/60	R
Sulfuric Acid	Up to 50	20/60	R
Milk	o.sol	20/60	R
Wine	o.sol	20/60	R
Toluene	ts-s	20/60	LR/NR
Trichloroethylen	ts-s	20/60	NR
Urea	sol	20/60	R
Oils (vegetable and animal)	ts-s	20/60	R/LR

**Abbreviations and Definitions**

**D: Durable**

The plastic pipes and fittings indicated with IDf in the table, will not adversely change in terms of properties where there is no external mechanical impacts, when used with chemical substances at specified temperature and concentrations.

**SD: Limited Durability**

Plastic pipes and fittings indicated with ISDf in the table may exhibit corrosion to a certain degree where there is no external mechanical impacts, when used with chemical substances at specified temperature and concentrations. Therefore the pipes indicated with ISDf can be used in the applications where small amount of corrosion is acceptable.

**DZ: Not-durable**

Plastic pipes and fitting parts that are indicated with "DZ" are not used since they are affected from chemical materials at a considerable extent.

**ts-s** Technical purity, liquid

**ts-g** Technical purity, gas

**Sat. sol.** Saturated solution

**Opr. sol.** Working solution is the most common concentration used in the industry.

**Sol.** Solution

**R** Resistance

**LR** Limited Resistance, corrosion may occur

**NR** Non Resistance

## Production Methods

FKS pipes are produced according to DIN 16961-1, DIN 16961-2 and TS 12132 standards. FKS pipes are available in three different profile ranges according to application areas and purposes.

- PR series : External profiled pipe
- SQ : In-wall profiled pipes
- VW series : Plain spiral (non-profile) pipes

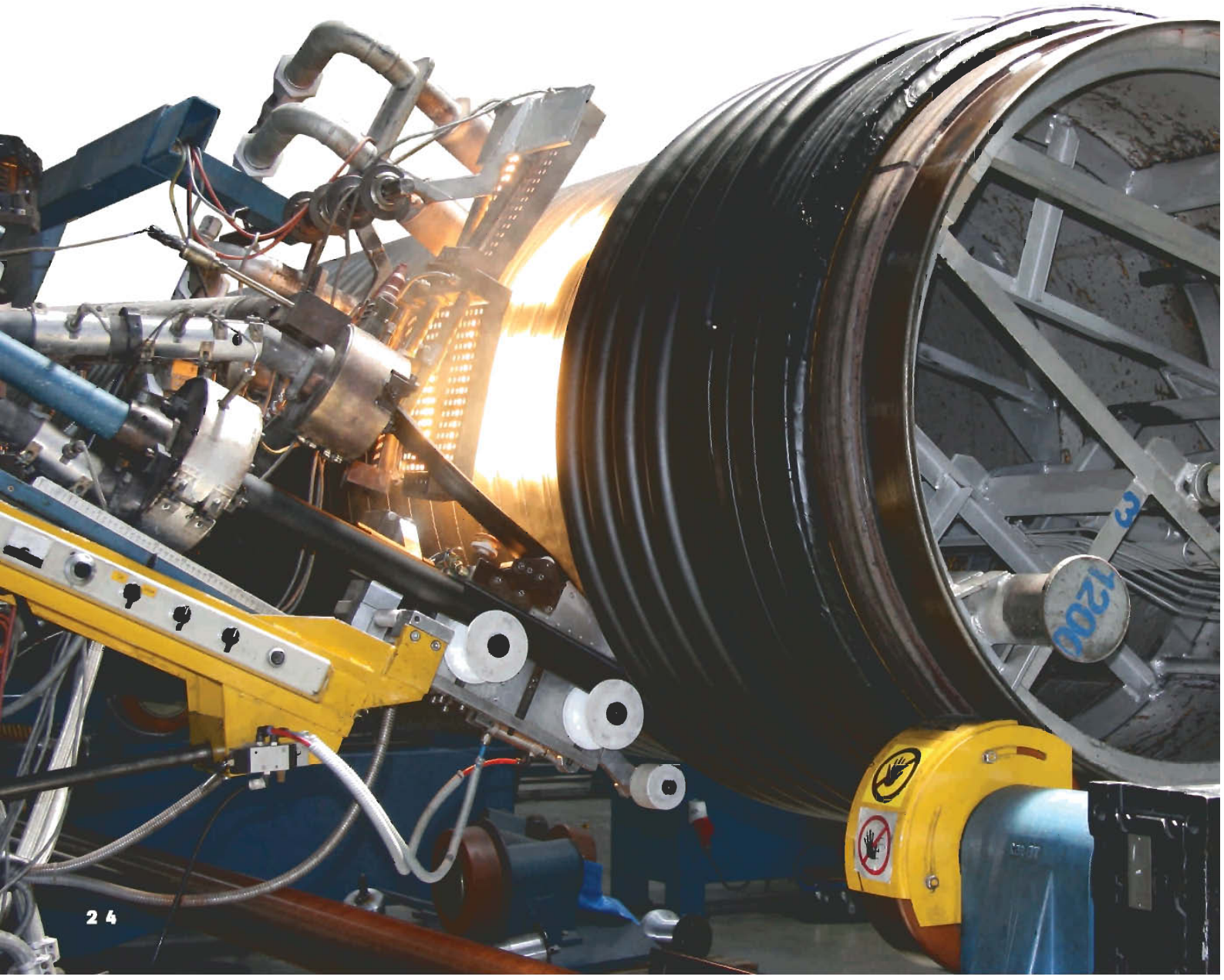

## PR Series FKS Pipes

In FKS pipe system, PR series pipes are the pipes with smooth internal surface and profile-wound external surface. These types of pipes are generally preferred for sewage systems and gravity transfer of fluids and their main specifications are as follows:

These pipes provide a good hydraulic flow with their smooth internal surface and offer ease of maintenance and control with their light colored internal surfaces and also they are suitable for grounding with PE-el coating. Since PR series pipes offer high ring rigidity with their profile structures on external surfaces as well as good anchorage with the earth, they have a high strength against loads such as heavy traffic etc. FKS pipes can be produced with muff structure up to 3.600 mm internal diameter joined with electro-fusion welding and they also allow for joining with welding to offer ultimate tightness and can be manufactured with flange fittings or to be applied with butt-welding.

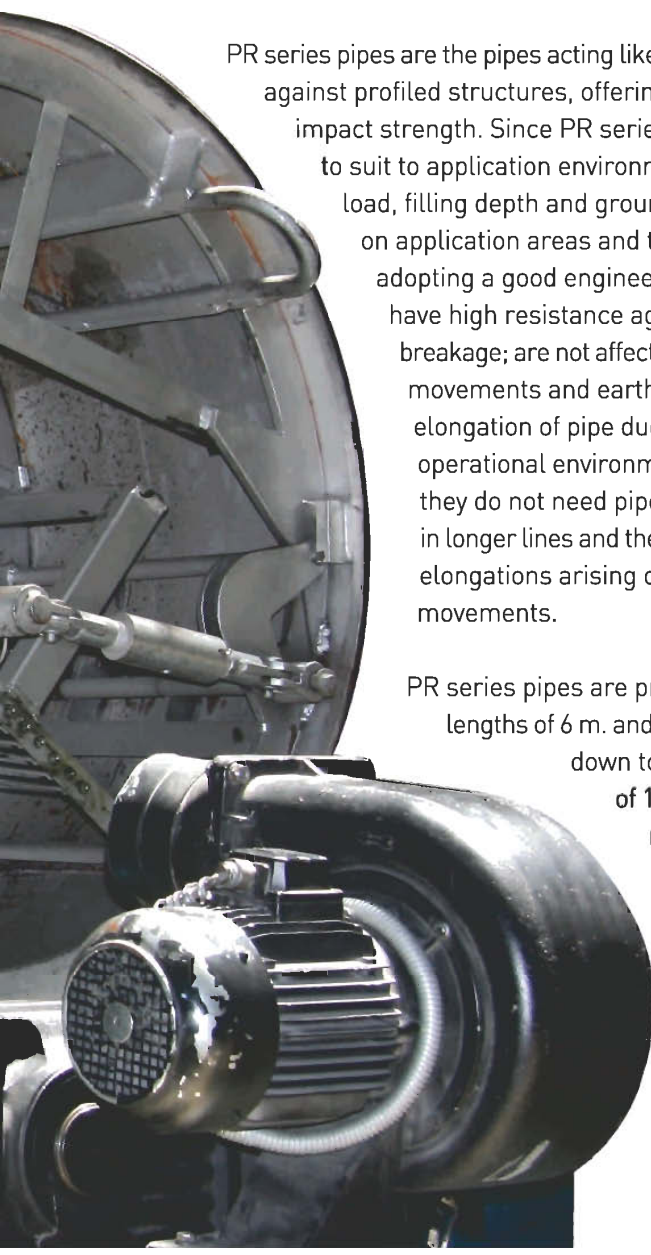

PR series pipes are the pipes acting like a suspension system against profiled structures, offering flexibility and high impact strength. Since PR series pipes are designed to suit to application environments such as traffic load, filling depth and ground water depending on application areas and they are produced adopting a good engineering technique. They have high resistance against impacts and breakage; are not affected from seismic earth movements and earthquakes. Since elongation of pipe due to heat arising from operational environment is not significant, they do not need pipe compensators even in longer lines and they adapt the undesired elongations arising due to seismic movements.

PR series pipes are produced in standard lengths of 6 m. and they can be produced down to a minimum length of 1 m. upon request and made of HDPE raw material.

# Production Methods

## Technical Specifications of PR Series FKS Pipes

### Wall Structure and Exterior Profile Types of PR Series FKS Pipes

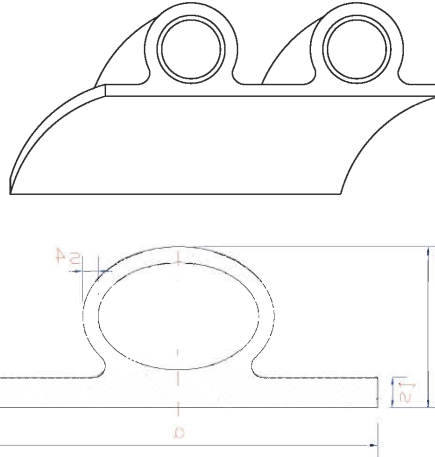

Wall section and technical structure of PR series FKS pipes

### Technical Details of PR Series FKS Pipes

Profile No	Sae [mm.]	e [mm.]	IX [mm <sup>4</sup> /mm.]	Optimum Usable Diameter	
				Without Traffic Load	Without Traffic Load SLW 60
PR 34-1.2	24	11	1.223	900	700
PR 42-1.9	28	13.27	1.876	1.200	900
PR 42-2.6	31	14.79	2.596	1.300	1.000
PR 54-4.5	37.9	18.27	4.547	1.600	1.100
PR 54-5.5	40.5	19.70	5.529	1.700	1.200
PR 54-7.0	43.9	21.12	7.035	1.900	1.300
PR 54-8.5	46.7	22.41	8.492	2.000	1.400
PR 54-10.3	49.8	23.70	10.297	2.100	1.700
PR 54-11.8	52.1	28.88	11.774	2.200	1.800
PR 54-12.9	53.7	26.14	12.917	2.200	1.900
PR 54-16.3	58.1	26.20	16.321	2.400	2.100
PR 54-19.8	62	31.20	19.844	2.500	2.300

Sae: Equal value wall thickness    IX: Moment of Inertia    e: Distance of Inertia  
 Note: Above table is just for reference purposes. Final calculations will be made and provided by producer.

Static calculations must be made by taking earth depth, ground water and traffic load (special loads other than traffic load; train, airplane etc.) into account. Static calculation and tests can be carried out with special software programs.

Side Section and Joining Details of PR Series FKS Pipes

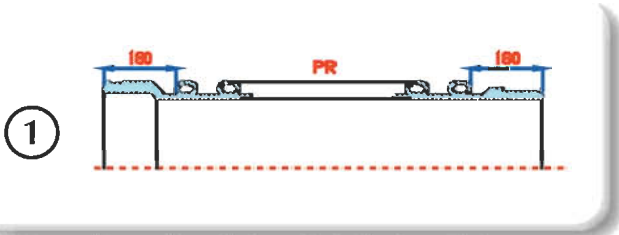

One end is muffed coupled with electro-fusion welding fitting and other end is centric spigot pipe section.

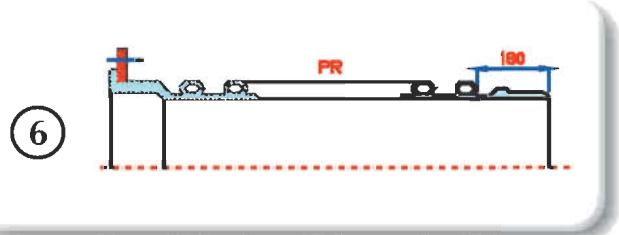

One end is female centric flange and muffed, other end is centric spigot pipe section.

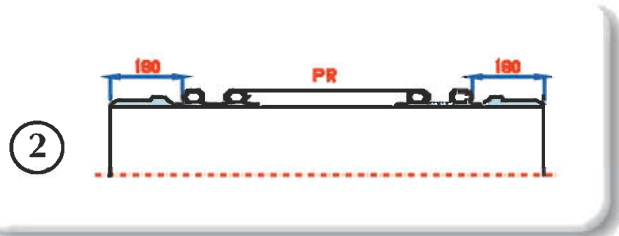

Both ends are centric spigot pipe section.

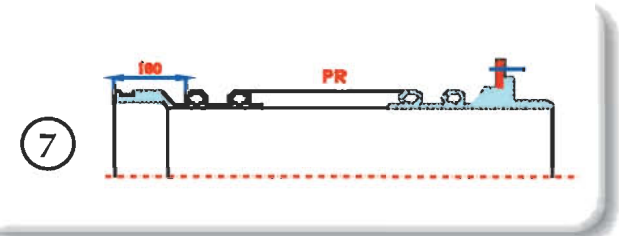

One end with electro-fusion muffed and other end is male centric flanged pipe section.

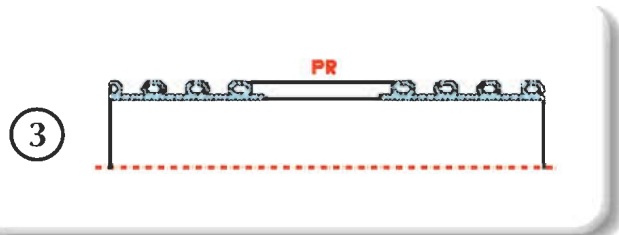

Both ends are plain pipe section.

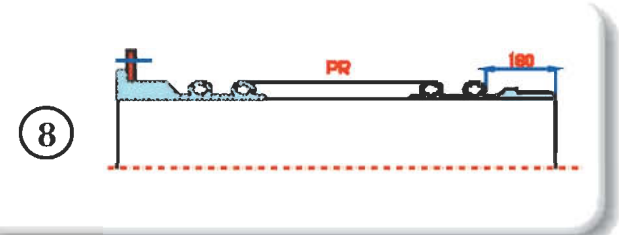

One end is flanged and other end is centric spigot pipe section.

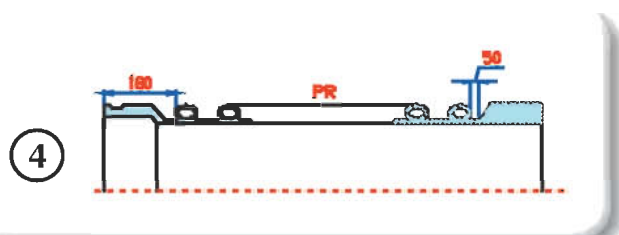

Pipe section of which one end is electro-fusion welding muffed, other end is spigot suitable for butt welding

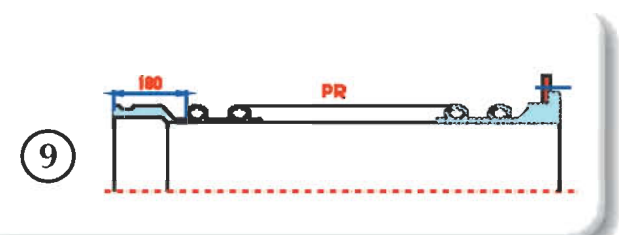

One end with electro-fusion muffed and other end is flanged pipe section.

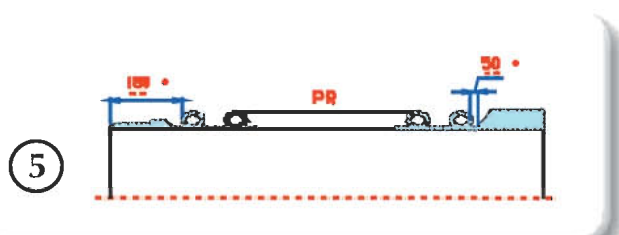

One end is centric spigot; other end is pipe section suitable to butt welding

## Production Methods

### **SQ Series FKS Pipes**

In FKS pipe system, SQ series pipes are generally designed for use in industrial silo and tank production. General specifications of SQ series pipes are the same with those of PR series; the main specifications of SQ series pipes as follows; Designed for silo and tank production, SQ pipes have smooth internal surface as well as external surfaces; pipe wall is profile-supported with one or multiple layers. Since external surface of SQ pipe is particularly smooth, it is very suitable for methane chimneys and methane tanks of waste storage areas in solid waste projects.

On the other hand, since HDPE raw material used in production of SQ pipes is a completely hygienic product, the silos and tanks built with these pipes are ideal for storing food.

SQ series pipes are exclusively made of HDPE raw material, its internal surface can be in different colours. Although these series of pipes with a diameter up to 1,600 mm are suitable for joining with butt welding, generally they are generally welded by extrusion welding from inside and outside. It is also possible to install ladder, special sections, couplings, covers and any kind of engineering application with HDPE materials without deteriorating the system integrity of silos and tanks built with these type of pipes.

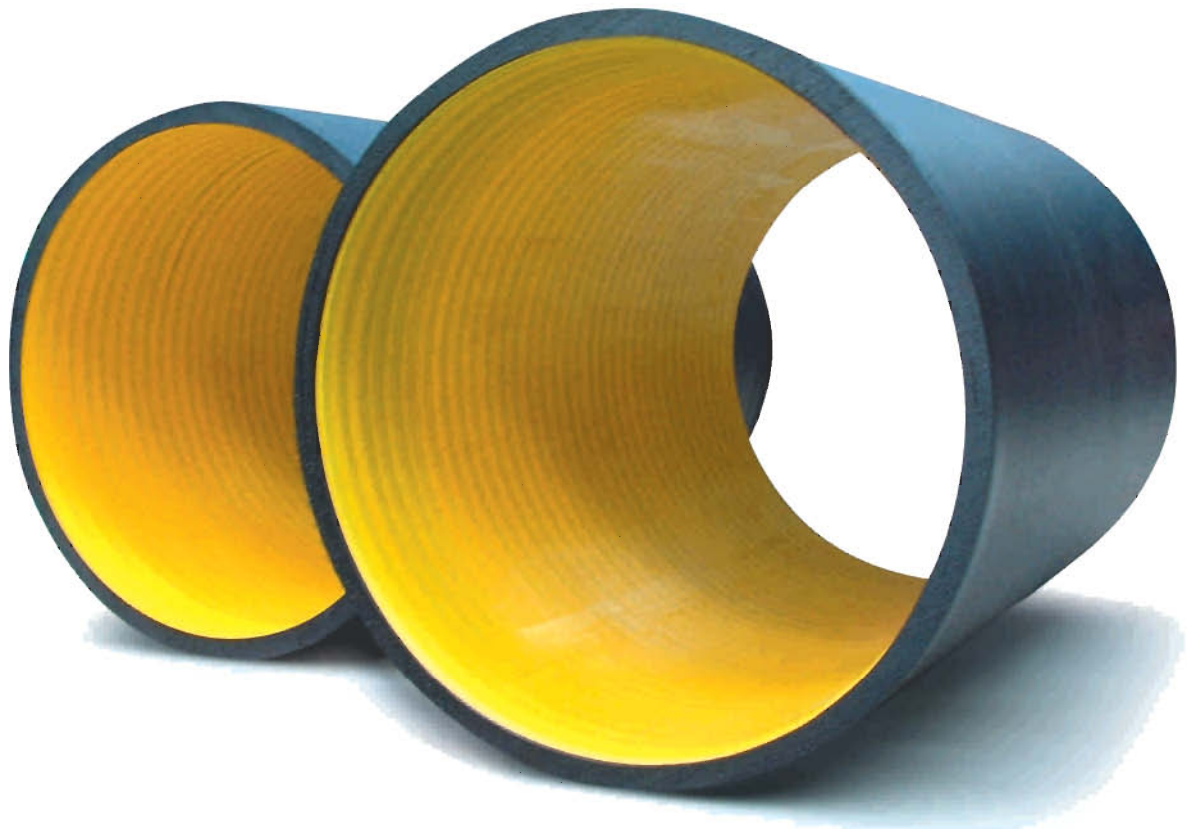

**SQ series pipes are produced in three types according to application areas.**

1. SQ1 Series Single Layer Profile-Supported Pipes
2. SQ2 Series Double Layer Profile-Supported Pipes
3. SQ3 Series Triple Layer Profile-Supported Pipes

**SQ1 Series Single Layer Profile-Supported Pipes**

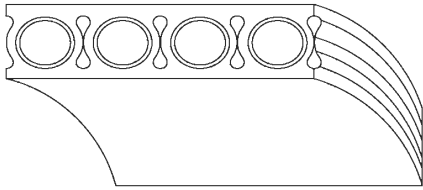

Wall section and technical structure of SQ1 series single layer profile-supported FKS pipes



**Technical Details of SQ1 Series FKS Pipes**

Profile No	Sae [mm.]	e [mm.]	IX [mm <sup>4</sup> / mm.]	Optimum Usable Diameter	
				Without Traffic Load	Without Traffic Load SLW 60
SQ 34-09	48.30	26.00	9.411	2.100	1.900
SQ 34-10	49.50	26.10	10.089	2.200	2.000
SQ 34-11	51.60	26.32	11.461	2.200	2.000
SQ 34-12	53.60	26.65	12.863	2.300	2.100
SQ 34-15	57.40	27.53	15.794	2.500	2.300
SQ 34-18	61.00	28.63	18.945	2.600	2.400
SQ 34-22	64.50	29.90	22.381	2.800	2.600
SQ 34-26	67.90	31.27	26.107	2.900	2.700

Sae: Equal value wall thickness    Ix: Moment of Inertia    e: Distance of Inertia  
 Note: Above table is just for reference purposes. Final calculations will be made and provided by producer.

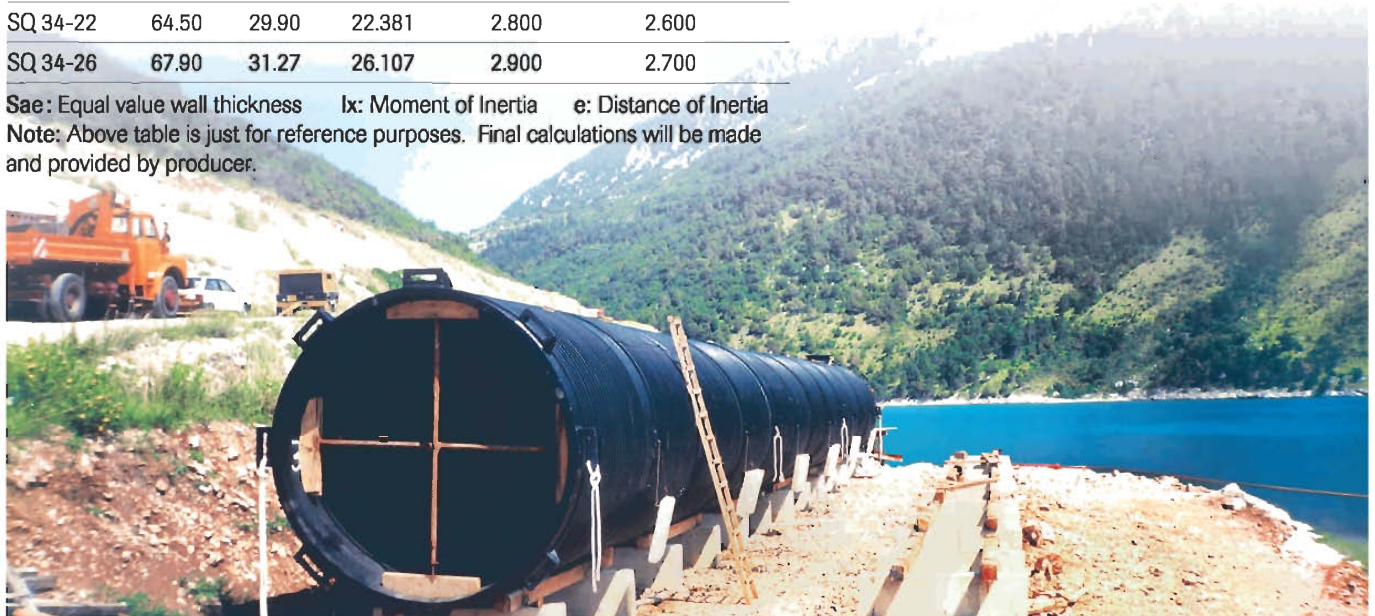

# Production Methods

## SQ2 Series Double Layer Profile-Supported Pipes

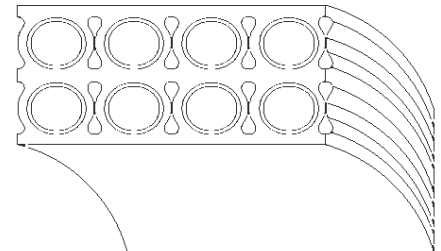

Wall section and technical structure of SQ2 series double layer profile-supported FKS pipes

### Technical Details of SQ2 Series FKS Pipes

Profile No	Sae [mm.]	e [mm.]	IX [mm <sup>4</sup> / mm.]	Optimum Usable Diameter	
				Without Traffic Load	Without Traffic Load SLW 60
SQ 34-46	82.60	48.50	46.884	3.400	3.300
SQ 34-53	86.50	48.59	53.949	3.500	3.500
SQ 34-65	92.50	49.06	65.854		
SQ 34-78	97.90	49.87	78.078		
SQ 34-90	102.90	50.93	90.771		
SQ 34-104	107.70	52.20	104.050		
SQ 34-118	112.30	53.62	118.050		
SQ 34-132	116.80	55.18	132.840		

Optional Available for all diameters

Sae: Equal value wall thickness    Ix: Moment of Inertia    e: Distance of Inertia  
 Note: Above table is just for reference purposes. Final calculations will be made and provided by producer.





### SQ3 Series Triple Layer Profile-Supported Pipes

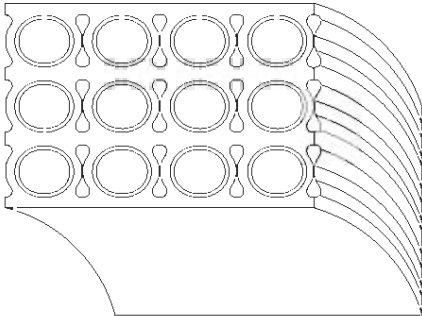

Wall section and technical structure of SQ3 series triple layer profile-supported FKS pipes

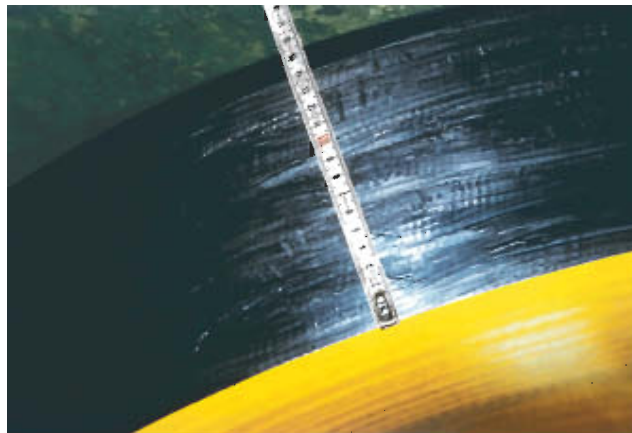

### Technical Details of SQ3 Series FKS Pipes

Profile No	Sae [mm.]	e [mm.]	Ix [mm <sup>4</sup> / mm.]	Optimum Usable Diameter	
				Without Traffic Load	Without Traffic Load SLW 60
SQ 34-164	125.6	74.00	16.499		
SQ 34-181	129.6	74.10	18.143		
SQ 34-197	133.4	74.30	19.795		
SQ 34-214	137.1	74.60	21.458		
SQ 34-245	140.5	75.00	23.137	Optional Available for all diameters	
SQ 34-248	143.9	75.45	24.834		
SQ 34-265	147.7	76.00	26.553		
SQ 34-282	150.3	76.60	28.298		

Sae: Equal value wall thickness    Ix: Moment of Inertia    e: Distance of Inertia  
 Note: Above table is just for reference purposes. Final calculations will be made and provided by producer.



# Production Methods

## Side Section and Coupling Details of SQ Series FKS Pipes

①



One end is muffed coupled with electro-fusion welding fitting and other end is centric spigot pipe section.

⑦



One end is centric spigot; other end is pipe section suitable to butt welding.

②



Both ends are centric spigot pipe section.

⑧



One end is female centric flange and muffed, other end is centric spigot pipe section.

③



Both ends are plain pipe section.

⑨

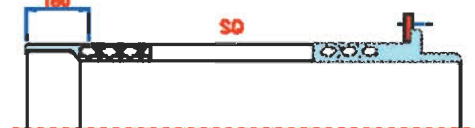

One end with electro-fusion muffed and other end is male centric flanged pipe section.

④

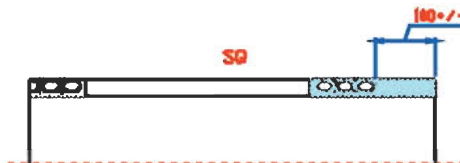

One end is straight, other end is pipe section suitable for butt welding.

⑩

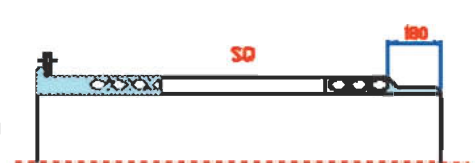

One end is flanged and other end is centric spigot pipe section.

⑤



Pipe section with both ends suitable for butt welding.

⑪

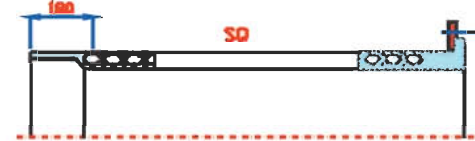

One end with electro-fusion muffed and other end is flanged pipe section.

⑥



Pipe section of which one end is electro-fusion welding muffed, other end is spigot suitable for butt welding.

## VW Series FKS Pipes

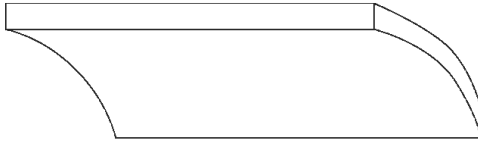

Wall section and technical structure of VW series single layer profile-supported FKS pipes.

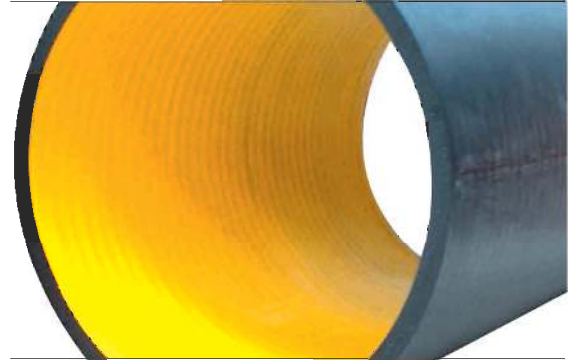

### Technical Details of VW Series FKS Pipes

Profile No	Sae [mm.]	e [mm.]	IX [mm <sup>4</sup> / mm.]	Optimum Usable Diameter	
				Without Traffic Load	Without Traffic Load SLW 60
VW 5	5	2.50	10.40		
VW 10	10	5.00	83.30	400	400
VW 15	15	7.50	281.25	600	600
VW 20	20	10.00	666.60	900	800
VW 25	25	12.50	1.302	1.100	1.000
VW 30	30	15.00	2.250	1.300	1.100
VW 35	35	17.50	3.570	1.500	1.300
VW 40	40	20.00	5.333.30	1.800	1.500
VW 45	45	22.50	7.573.70	2.000	1.700
VW 50	50	25.00	10.416	2.200	1.900
VW 55	55	27.50	13.864	2.400	2.100
VW 60	60	30.00	18.000	2.600	2.300
VW 65	65	32.50	22.885	2.700	2.500
VW 70	70	35.00	28.583	2.900	2.800
VW 75	75	37.50	35.156	3.100	3.000
VW 80	80	40.00	42.666	3.300	3.200
VW 85	85	42.50	51.177	3.400	3.400
VW 90	90	45.00	60.750	3.600	3.600

Sae: Equal value wall thickness IX: Moment of Inertia e: Distance of Inertia

Note: Above table is just for reference purposes. Final calculations will be made and provided by producer.



## Production Methods



### VW Series FKS Pipes

In FKS pipe system, VW series pipes are industrial pipes with smooth internal and external surface and without profile-support. These pipes are used in silo, tank and pipe productions and in special projects where high load strength is required.

Designed to be durable against heavy operational conditions, VW pipes have smooth external and internal surfaces, the pipe wall is completely solid. In these pipes, it is possible to produce internal surface in different colours in the applications where HDPE raw material is used.

VW Series pipes are made of HDPE and PP raw material. As a standard, pipes made up of HDPE raw material can have wall thicknesses ranging from 5 mm to 100 mm; pipes made of PP raw material can have wall thicknesses from 5 mm to 80 mm. Although it is possible to produce pipes that are thicker than these dimensions, it is not economical in terms of welding and joining. It is also possible to produce special parts such as large diameter flange adapter by producing pipes that have higher wall thickness than standard dimensions of VW series pipes and processing them with lathe.

It is possible to weld the VW series pipes with butt welding up to 1.600 mm. In general, these pipes are joined with internal and external extrusion welding method.

It is also possible to produce any kind of engineering applications such as sections, fittings with VW series pipes, just like SQ series pipes, in terms of system integrity.



Side Section and Joining Details of VW Series FKS Pipes

1

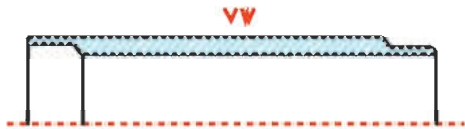

One end is muffed coupled with electro-fusion welding fitting and other end is centric spigot pipe section.

6

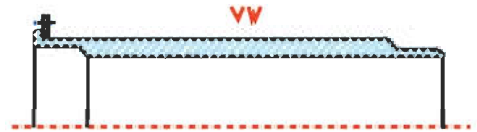

One end is female centric flanged and muffed, other end is centric spigot pipe section.

2

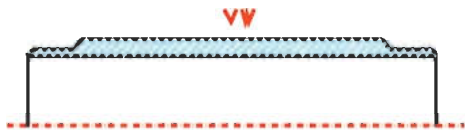

Both ends are centric spigot pipe section.

7

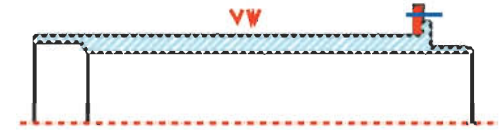

One end with electro-fusion muff and other end is male centric flanged pipe section.

3

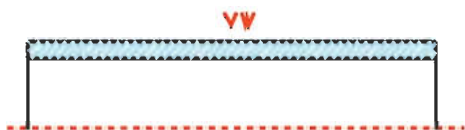

Both ends straight pipe section / Pipe section suitable for butt welding.

8

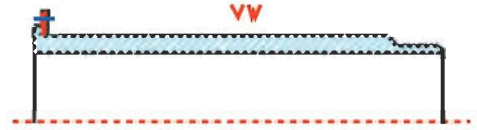

One end is flanged and other end is centric spigot pipe section.

4

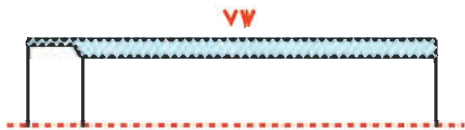

One end is with electro-fusion muff , other end is spigot pipe section suitable for butt welding.

9

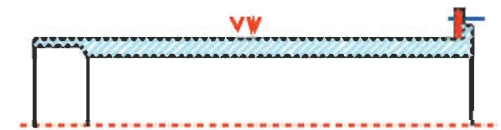

One end with electro-fusion muff and the other end is plain pipe section.

5



One end is spigot pipe section; other end is pipe section suitable for butt welding.

# FKS Pipe and Fittings

## Joining Methods

FKS pipe and manholes are designed and produced suitable for all different joining techniques. End sections of FKS pipes, manhole entrance and exit parts are produced in a structure allowing different joining methods, depending on their purposes.

### Electro-fusion Welding Method

For pipes which are produced with this welding method, inside of the muff section is prepared with electro-fusion. Specially alloy resistor wires used for electro-fusion fittings are embedded inside the muff to prevent deformation and the ends which will be connected to the welding machine are left free enabling a comfortable welding application. In large diameter pipes, welding can be carried out by working inside the pipe. FKS pipes can be produced with electro-fusion welding up to 3.600 mm of internal diameter.

Joined with electro-fusion welding method, FKS pipes can be demounted for 5 times and joined again with electro-fusion welding method, if necessary attention is paid.

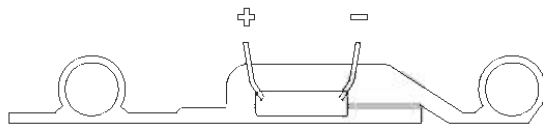

FKS pipe electro-fusion welding muff structure.

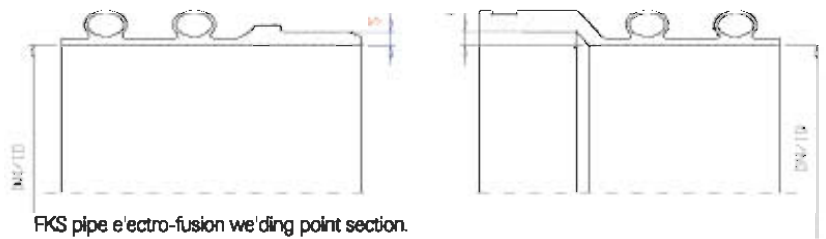

FKS pipe electro-fusion welding point section.

The spigot tip entering inside the muff section of pipe is produced with a precision of millimeter required for a healthy welding as well as comfortable inserting inside muff section. Either internal diameter of muff section or external diameter of spigot tip and wall thicknesses of the pipe is at standard dimensions.

### FKS Pipe Electro-fusion Welding Machine

For a good welding, the properties of welding machine are as important as the welding fitting and welding operation. The technical specifications of welding machine that will be used for welding FKS pipes are as follows.



Input voltage	: 380 Volt
Output voltage	: 8 - 48 Volt
Frequency	: 40 Hz - 70 Hz
Ampere	: 16 A
Welding interval	: Min. 20 - Max. 30 minutes

## FKS Pipe Electro-fusion Welding Parameters

The issues that must be paid attention during welding of FKS pipes with electro-fusion method are as follows:

- Welding area must be protected against contamination and sunrays, welding operation must be carried out at temperature levels of 5°C and above.
- Packing of muff and pipe ends must be removed just before the welding operation. Early unpacking will cause the contamination of parts to be welded.
- The parts of pipe which will be welded must be cleaned thoroughly with a cleansing agent or industrial alcohol just before welding.
- The insertion length of pipe end into the muff section must be certainly marked before assembly and the intertwining of the end sections of pipes must be carried out according to measured length.
- At insertion point, pipe surfaces must be parallel to each other. The external compression applied on pipe must be checked for correctness, insertion surfaces must not contain gaps, resistance tips must be aligned with top of the pipe.
- Stretching ring must always be placed inside the pipe in welding operation of pipes with 800 mm. diameter or above.
- Resistance tips must be seated fully inside the adapter carefully and screw-tightened and welding cables must be positioned over the pipe.
- Welding operator shall always insert his operator card in welding machine before welding.
- Stretching band must seat in its housing processed on external muff section and surfaces of the pipe to be welded must be compressed in contact with each other using a stretching tool. When welding process starts they shall be further tightened to ensure that welding points are sealed well.
- In the beginning of welding, voltage rate and welding time must be adjusted on the machine or information on the barcode should be scanned by the machine.
- After completion of welding, welding machines must be removed from adapter section carefully.
- After completion of welding operation, stretching band and internal ring must never be removed during cooling period. This apparatus must remain on the pipe until cooling process ends.
- Tightness test of pipe welding must be carried out before placing the pipe top filling in accordance with DIN 1610 standard.

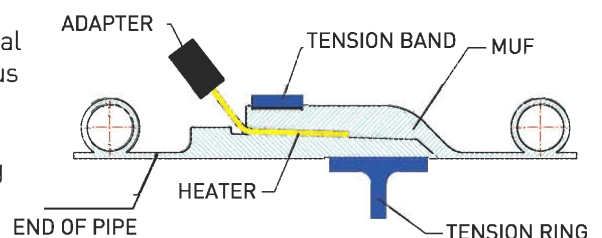

# FKS Pipe and Fittings

## Joining Methods

### FKS Pipes Electro-fusion Welding Parameters

Diameter	Welding Voltage	Welding Time (seconds)				
		30°C	20°C	15°C	10°C	5°C
400	15	1605	1786	1965	2160	2235
500	17	1745	1938	2131	2340	2425
600	20	1688	1875	2065	2265	2345
700	22	1785	1985	2185	2400	2485
800	25	1725	1920	2110	2320	2400
900	28	1688	1875	2065	2265	2345
1.000	30	1760	1960	2150	2365	2445
1.100	35	1720	1910	2100	2305	2385
1.200	36	1688	1875	2065	2265	2345
1.300	40	1560	1730	1900	2090	2160
1.400	42	2115	2350	2590	2835	2940
1.500	42	2820	3135	3450	3785	3900
1.600	45	3075	3415	3755	4120	4270

Excluding the extraordinary conditions, it is not suggested to perform welding under 5°C. If welding must be performed under 5°C, pre-heating must be carried out according to the above data. After completion of pre-heating, main welding operation must be carried out.





## Butt Welding Fusion Method

FKS pipes can be produced for butt welding method according to the specifications of project to be implemented. However, since there are technical restrictions in terms of either diameter or wall thickness in butt welding method, these restrictions are that the diameter has to be between 300 mm to 1,600mm , and the wall thickness can be maximum 110 mm. Butt welding process is carried out according to DVS 2207 standard. The points that require attention in joining FKS pipes with butt welding are as follows:

- The ambient temperature must not be under 5°C where butt welding will be carried out.
- The wall thicknesses of pipes to be fused must be equal, the difference in wall thicknesses of two pipes must not exceed maximum 10%.
- Before starting to weld, welding surfaces must be shaved and its oxidation must be removed and welding surfaces must contact with each other completely.
- The welding surface must be cleaned with industrial alcohol before heating with iron.
- Welding iron temperature must be between 200-220°C. Upper heat limits must be selected for the pipes which have low wall thicknesses and lower heat values shall be used for high wall thicknesses.
- After starting the welding operation, joining pressure values of pipes must be kept equal while the weld is cooling.
- For FKS sewage pipes, welding pressure test must be conducted according to DIN 1610 standard and for pressurized potable water lines according to EN 805 Standard.

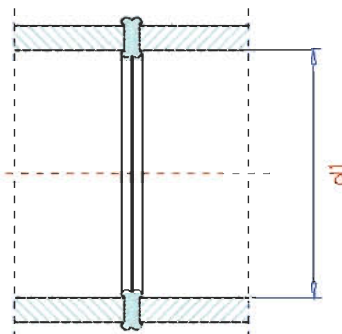

FKS pipe butt welding joint point section.

HDPE Boruların 20°C Ortam Isısında Optimum Kaynak Süreleri

# FKS Pipe and Fittings

## Joining Methods

### Optimum Welding Times of HDPE Pipes under 20°C Ambient temperature

Pipe Wall Thickness (mm.)	Welding Pressure 0.15 N/mm2 Lip Load. (mm.)	Heat Time 0.02 N/mm2 (seconds)	Heating Iron Removing Time (seconds)	Pipe Joining Pressure Operation Time (seconds)	Cooling Time (minutes)
.....4,5	0.5	.....45	.....5	.....5	.....6
4,5.....7	1.0	45.....70	5.....6	5.....6	6.....10
7.....12	1.5	70.....120	6.....8	6.....8	10...16
12.....19	2.0	120...190	8.....10	8.....11	16...24
19...26	2.5	190...260	10...12	11...14	24...32
26...37	3.0	260...370	12...16	14...19	32...45
37...50	3.5	370...500	16...20	19...25	45...60
50...70	4.0	500...700	20...25	25...35	60...80

### Pipe Welding area Calculation Formula

$$A_{\text{Pipe}} = \frac{(d_a^2 - d_i^2) \cdot \pi}{4} \text{ (mm}^2\text{)}$$

A pipe : Pipe Welding Area  
 da : External Diameter  
 di : Internal Diameter  
 dm : Medium Diameter

$$\text{Or } \approx d_m \cdot \pi \cdot s \text{ (mm}^2\text{)}$$

### Welding Compression Force Calculation:

$$F = p_{\text{Specific}} \cdot A_{\text{Pipe}} \text{ (N)}$$

A pipe : Pipe Welding Area  
 F : Compression Force  
 Specific : PE = 0.15 N/mm2  
 : PP = 0.10 N/mm2

### Butt Welding Stages

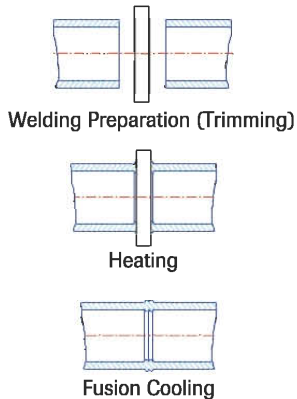

### Butt Welding Operation Time Chart

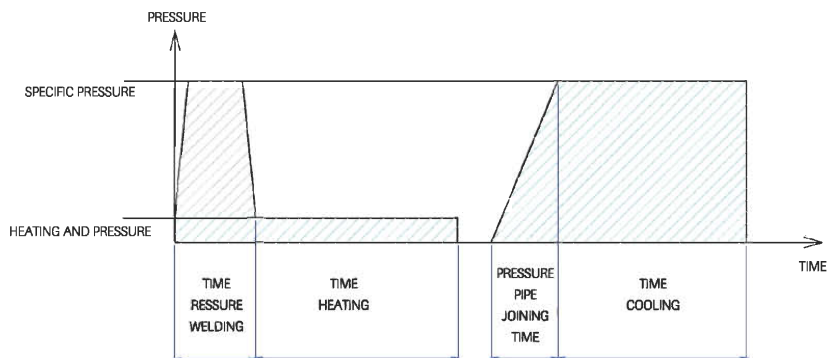

## Extrusion Method

FKS pipes can be joined with extrusion welding from inside and outside at muff insertion points. Even though it is possible to apply extrusion welding on plain pipes without muff, this welding method is generally used in special projects such as production of fitting parts such as elbow, y-branches produced from FKS pipes and special technical applications such as manhole, tank etc.

- Extrusion welding cannot be used to be employed in high pressure lines. It can only be applied in pipes and manholes which will be used in low-pressure gravity flow lines. Extrusion welding machines are grouped under two types, even though they use the same method.
- Hot air blowing welding machines operated by electrode.
- Extrusion welding is carried out with hot air blowing welding machines which extrude the granule rawmaterial according to DVS 2207 standard.
- The points that require attention in joining FKS pipes with extrusion welding are as follows:
- The ambient temperature for extrusion welding must not be under 5°C.
- Extrusion welding must not be employed in gas pipes and pressurized potable water lines.
- The parts which will be welded and materials of welding electrode must be in the same class and the welding electrode diameters must be 3 or 4 mm.
- The surfaces to be welded must be very clean and welding must be applied after removing the surface oxidation with a scraper.
- Welding operation must always be carried out by directing the welding extruder at 45° angle to the surface to be welded.
- In large and deep welding operations, for each time, welding at maximum 4 mm thickness must be performed. After cooling, it must be cleaned with a scraper, then subsequent welding must be performed following the other and operation should be continued as such until the desired thickness is achieved.



# FKS Pipe and Fittings

---

## Joining Methods

### View of Double Sided Vertical Extrusion Welding

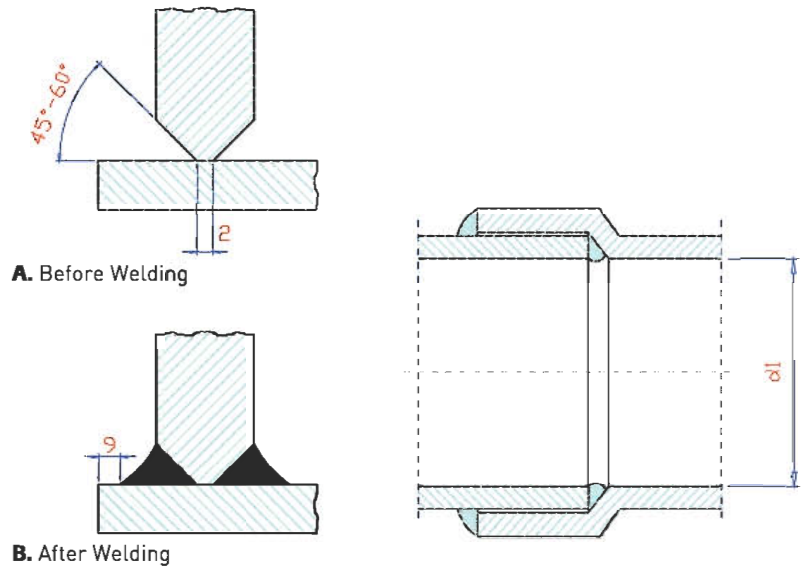

### Extrusion welding vertical part welding methods

### Extrusion welding operation methods

#### Single Sided Vertical Extrusion Welding Appearance

#### Extrusion Welding Preparation Details

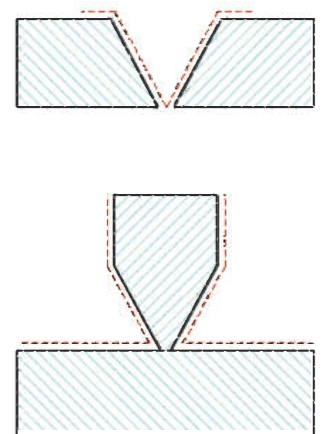
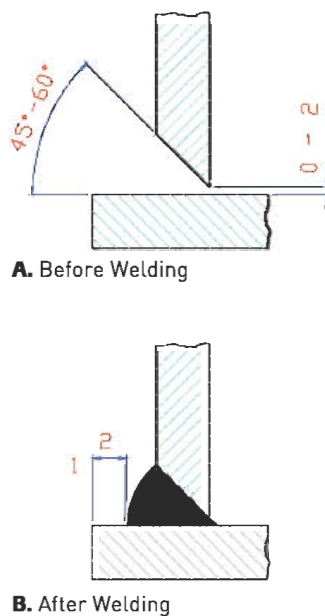

## Extrusion welding horizontal part welding methods

### Double Sided Vertical Extrusion Welding Appearance

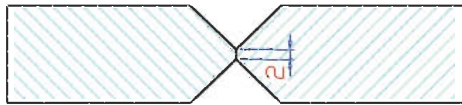

A. Before Welding



B. After Welding

### Single Sided Vertical Extrusion Welding Appearance

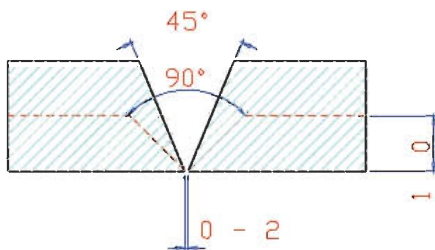

A. Before Welding

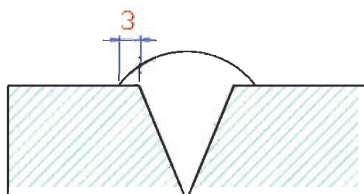

B. After Welding

### DVS 2207 Vertical Welding Parameters (Ambient Temperature 20°C)

Class of Material to be welded	Welding force (N)		Welding extruder hot air temperature value (°C)	Hot air flow (l/min)
	3 mm. Elektrode	4 mm. Elektrode		
HDPE	10...16	25...35	300...350	40...60
PP	10...16	25...35	280...330	40...60

Output diameter of hot air blowing tip of extruder must be 5 mm.

## FKS Pipe and Fittings

### Joining Methods

#### Socket-Gasket Method

FKS pipes are also produced suitable for socket-gasket method. One of the features expected from pipes during transferring of fluids is tightness. Leakage in Sewage lines as well as clogging due to plant roots intruding into the pipes are particularly significant problems that must be solved. Pipes used for transferring fluid move differently during the earth movements.

In these different works, socket-gasket method is not suggested unless it is required since pipes are subject to the risk of either leakage at joining points or plant roots intruding into the pipes at these points.

The gaskets used in this type of joining are manufactured according to EN 681 standards.

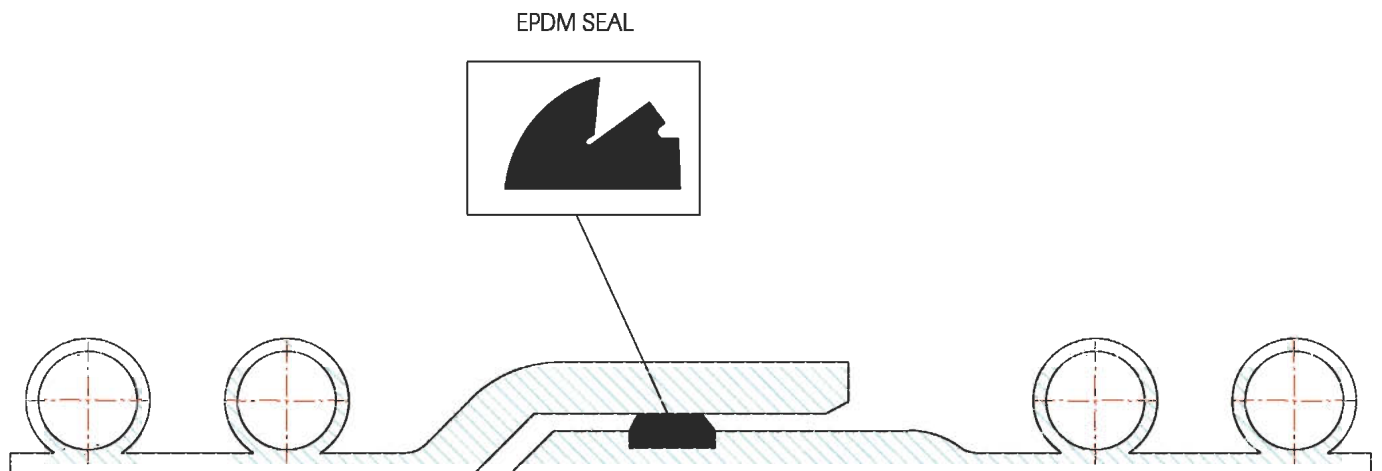

Socket-Gasket section of FKS pipes picture.



## Flange Method

Another joining method for FKS pipes is the flanged joining method specified in DIN 16963. This method is generally preferred for sea discharge applications, tanks and at joining points of pipes manufactured from different materials with FKS pipe. The most important advantage of flanged joining is being dismantlable.

Flanges used in flanged joining are galvanized steel complying with DIN 2501. It can also be manufactured from stainless steel according to project specifications. Flange adaptors can be produced as integrated with FKS pipe, or either adapter can be produced independent of pipe and then can be welded to the pipe in the construction site. Flanged joints of FKS pipes can be produced in types such as centric insert muff as well as with plain tip according to project specifications. While in order to sustain tightness at pipe join point in plain tip production, plain seal conforming to EN 681 standards can be used; in the centric flanged joining the seal with same features can be used as well as if seal cannot be used, extrusion welding can be applied at joining point inside the pipe in order to maintain tightness.

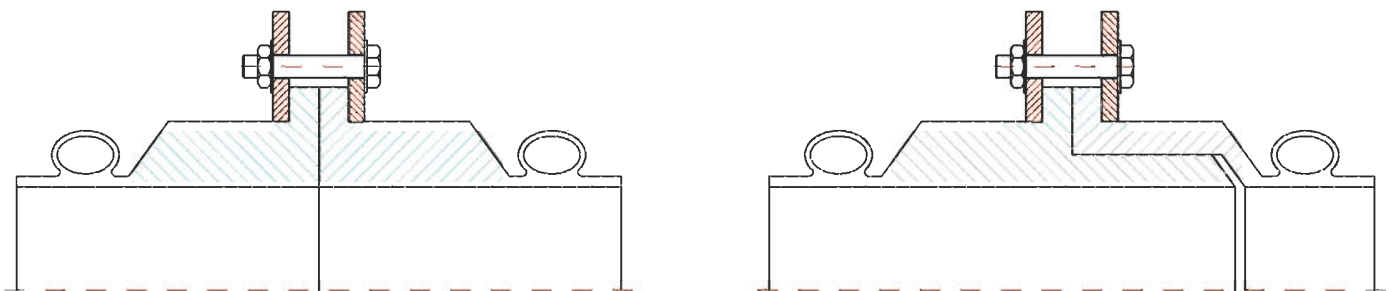

Picture of Flanged section of FKS pipes



# Sewage

## Application Methods

### Sewage Application Method of FKS Pipes

Sewage and rain water lines are the lines with very high initial investment costs and bearing constantly variable traffic, passing under the streets and roads of residential areas and covered with different materials. Due to their positions, not frequent interventions can be carried out on these lines and intervention costs are very high. Therefore, in order to ensure extended years of healthy service of Sewage lines, selection of good pipes is as important as a good project development.

The most frequent problems of Sewage systems is collapsing, breaking, clogging due to various reasons such as plant roots intruding into the pipe and ground water leaking into pipes. Particularly, ground waters leaking into the pipe occupies the capacity of Sewage lines as well as it increases the operation cost of treatment in systems equipped with treatment facility. In the lines installed near the sea shore, salty water intruding into the pipe corrodes mechanical equipments of treatment facilities as well as destroys the bacteria in the biological treatments resulting in complete disablement of the system.

Since FKS pipes are lightweight, small diameter pipes can be descended without requiring heavy-duty machines, and large diameter pipes can be descended through rope suspension system using small heavy-duty machines. As a rule, all pipes are placed in the trench in a straight line. But since FKS pipes are flexible in structure, small diameter pipes can be bended in a limited range; large diameter pipes can be bended at  $0,5^\circ$  while joining at muff section. (E.g.:5 cm for a pipe at a length of 5 m)

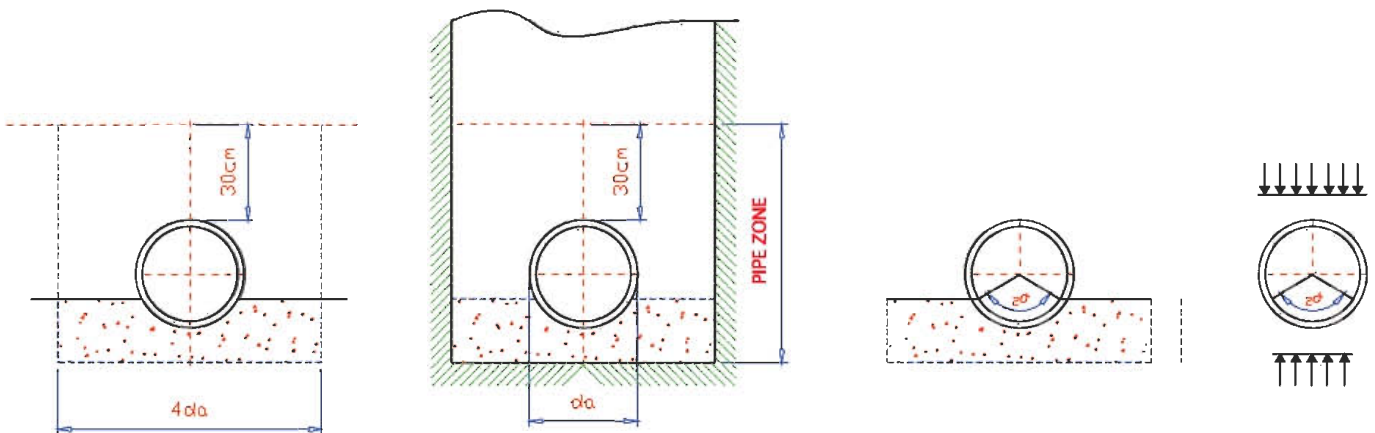



## Trench Excavation

Minimum trench width shall be ensured to have a 50 cm gap at both sides according to external diameter of pipe in order to maintain a good back-fill compaction. The bedding layer to be laid under the pipe must be "100 mm + 1/10 x pipe nominal diameter" as required by DIN 4033 standard. For FKS pipes, laying slope must be between 120° and 180°. It is required to know the soil structure of the land in either selection of FKS pipe or trench digging and filling operations. According to ATV 127, soil definitions are as follows.

- G 1:** Massive volcanic rocks, unweathered hard metamorphic rocks and hard sedimentary rocks. Very tight sand pebble, very hard clay and silt clay.
- G 2:** Loose volcanic rocks such as tuff and agglomerate, weathered cemented sedimentary rocks having discontinuous planes. Tight sand pebble, very hard clay and silt clay.
- G 3:** Soft, very weathered metamorphic rocks and cemented sedimentary rocks having discontinuous planes. Medium tight sand pebble, very hard clay and silt clay.
- G 4:** Soft, thick alluvium layers where underground water level is high. Loose sand, soft clay and silt clay.

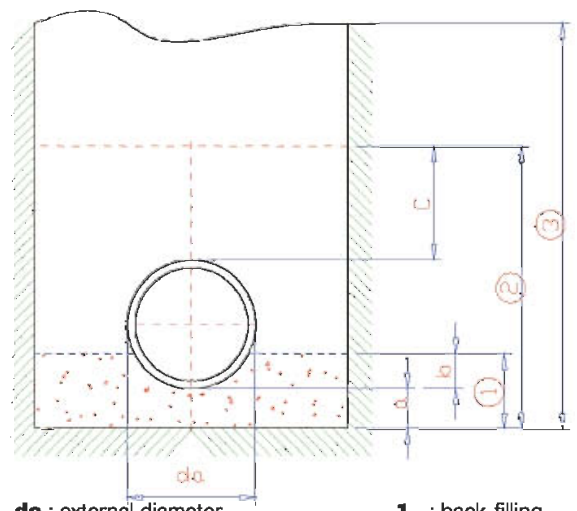

- da** : external diameter
- a** : bottom bedding filling thickness
- b** : top bedding filling thickness
- c** : top filling thickness
- 1** : back-filling thickness
- 2** : filling height
- 3** : trench depth

# Sewage

## Application Methods

### Trench Filling Material

Trench filling material must be selected among material classes which are durable, stable and with enough bearing capacity which will prevent the pipes from being damaged during compaction. Frozen materials and sharp-edged, sharp tipped stones etc. which will damage the pipe cannot be used as filling material. Materials specified below can be used for trench filling:

- Round edged filling material.
- Grain pebbles.
- Pebbles at different sizes.
- Sand.
- Gravel (maximum diameter 20 mm)
- Crushed stone (maximum 11 mm).

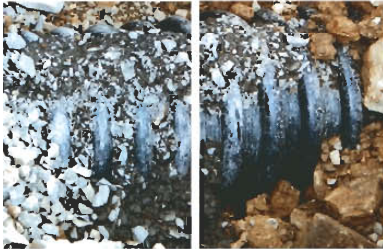

Appropriate for filling

Not appropriate for filling

### Bedding the pipes

If excavation soil is appropriate for filling, pipe can be laid down to the bottom of the trench directly without requiring bedding. If digging soil is not appropriate for filling (stoned, watery etc.) trench depth is increased and pipe is placed on the bedding after bedding which contains dry filling material (e.g.: sand) is reached. By selecting above materials as filling material, the bedding shall be laid down with a minimum thickness of 100 mm + 1/10 DN (mm).

If water exists in the trench; bedding must be made after discharging the water completely.

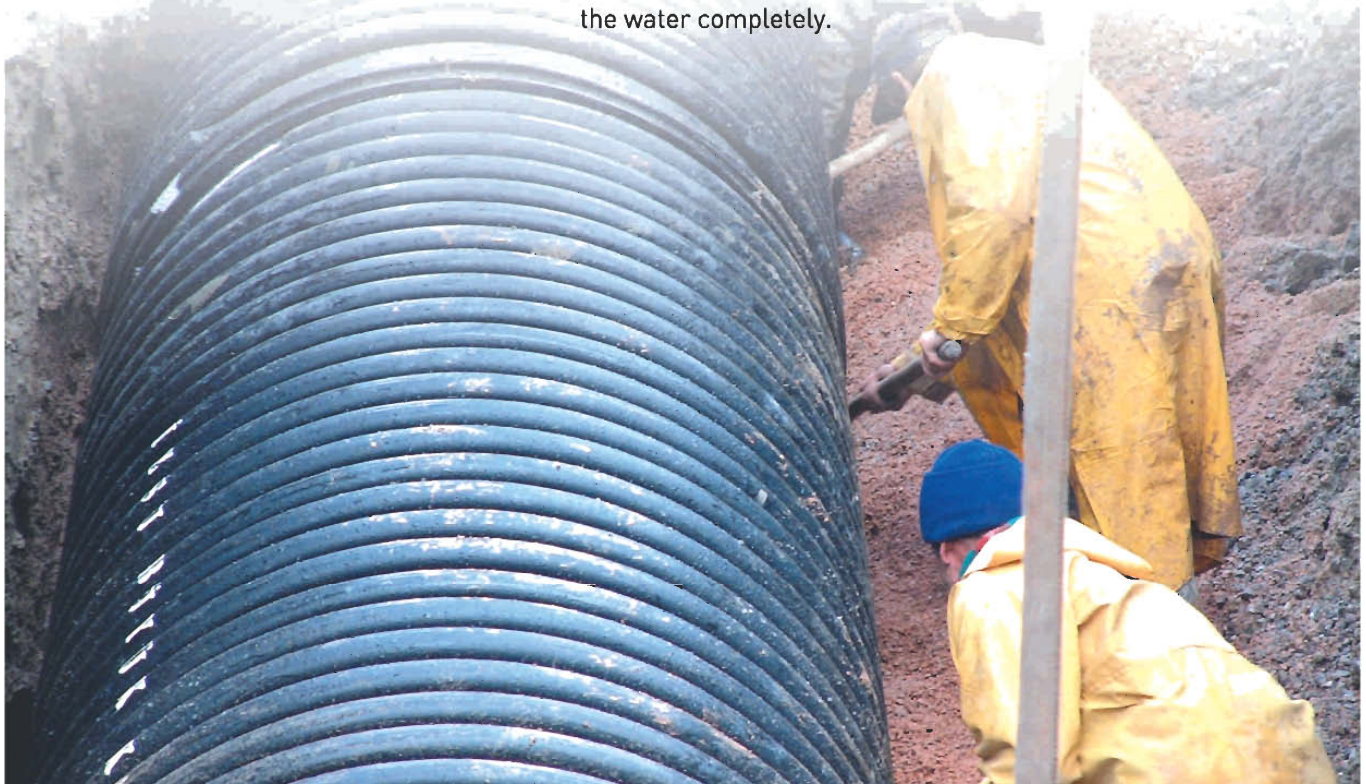

## Filling and Compacting

After laying FKS pipes and carrying out welding operation, tightness test must be conducted before filling operation. After laying the filling material at 30 cm thickness in both sides of the pipe, it must be compacted by compactors running slowly until 95% strength is realized. This operation shall continue at each 30 cm until 30 cm is formed above the pipe. After reaching 30 cm above pipe, filling operation must be completed with compactor at medium power. Compacting degree must comply with static calculations (it is not required to be between 92-95% at minimum.) Information about the required type of compactor during laying the filling, number of times that compactor shall make a pass over the filling and filling thickness are specified in the table according to filling stages.



### Filling material classes:

V 1 : Non-cohesive or slightly cohesive sand and pebble	Suitable to use
V 2 : Cohesive, mixed grain size sand and pebble	Very suitable to use
V 3 : Cohesive, non-grained soil, mud and clay	Not used

Filling material intruding inside the profiles of FKS pipes increases the load strength of pipe by integrating with pipe forming a good lining.

### Soil Compaction Rate, Filling Thickness and Compactor Transition Number Table

Compactor type	Compactor weight kg	Compacting with a Compactor								
		V 1			V 2			V 3		
		Available to use	Filling thickness cm.	Number of passes	Available to use	Filling thickness cm.	Number of passes	Available to use	Filling thickness cm.	Number of passes
<b>1. Light compactor (for filling)</b>										
Handheld compactor/Light	max 25 kg	+	max 15	2-4	+	max 15	2-4	+	max 10	2-4
Compactor/Medium	25-60 kg	+	20-40	2-4	+	15-30	3-4	+	10-30	2-4
<b>Round</b>										
Compactor/Light	max 100 kg	0	20-30	3-4	+	15-25	3-5	+	20-30	3-5
Compactor/Light	max 100 kg	+	max 20	3-5	0	max 15	4-6	-	-	-
/Ligh	100-300kg	+	20-30	3-5	0	15-25	4-6	-	-	-
<b>Cylinder</b>										
Compactor/Light	max 600 kg	+	20-30	4-6	0	15-25	5-6	-	-	-
<b>2. Medium and Heavy compactor (for top filling)</b>										
Handheld compactor/Medium	25-60 kg	+	20-40	2-4	+	15-20	2-4	+	10-30	2-4
Compactor/Heavy	60-200 kg	+	40-50	2-4	+	20-40	2-4	+	20-30	2-4
Round/Medium	100-500 kg	0	20-40	3-4	+	25-35	3-4	+	20-30	3-5
Compactor/Heavy	max 500 kg	0	30-50	3-4	+	30-50	3-4	+	30-40	3-5
Compactor/Medium	300-750 kg	+	30-50	3-5	0	20-40	3-5	-	-	-
<b>Cylinder</b>										
Compactor/Medium	600-8.000 kg	+	20-50	4-6	+	20-40	5-6	-	-	-

## Sewage

### Application Methods

#### Top Filling

While filling material is discharged into the trench, materials must be discharged at small amounts in order to avoid moving the pipeline and compaction must be carried out according to conditions stated in the table for stability safety. Compactor can pass over the pipes after pipes are welded and the backfill passes 1 m. above the top of pipe. If filling is not over 1 m. above the top of pipe, it is inconvenient to pass any kind of vehicle including compactor and heavy-duty machines over the pipe. While compacting, a compactor must always be used. Since the compacting with a pounder will not be sufficient and healthy, pounder is not suitable for this operation.

After covering at least 30 cm. over the pipe with filling materials and necessary compaction is carried out, it can be covered with soil attained during digging. If there is traffic load over the trench, this material must also be compacted with a compactor.

#### Relining Application Method of FKS Pipes.

Infrastructure applications are difficult and need hard working. It is always possible to encounter with surprises arising from uncertainties during the application stage. Most of the time, pipes must be laid in the narrow and covered areas on which making open excavation is impossible during the applications.

This type of problems are mostly encountered in the units where multi-storey buildings housing more people are built after demolishing a less-populated building without renovating the infrastructure in residential areas. Current infrastructure must be renovated when it becomes unusable due to collapses, clogging or becomes insufficient in terms of capacity in the course of time.

In such cases, FKS pipes can be passed through old lines with relining method. Especially, due to very low friction coefficient compared to concrete pipe, as well as the possibility of using the one smaller diameter than the current concrete pipes, FKS pipes can be passed through concrete pipes providing a permanent and economic solution of the problem without requiring extensive diggings.

In relining method, FKS pipe is pushed through the current malfunctioned line by welding the pipes with each other inside the trench to be opened at the start of tunnel or pipeline by means of continuous pushing or pulling method. The most important point in this respect is carrying out good lining operation by injecting concrete into the gap between current pipe and FKS pipe in order to ensure healthy service of the system for extended years.



## Solid Waste Projects Application Method with FKS Pipes

In today's technology society where industry develops rapidly as the population increases at a fast pace, it is a well-known fact that domestic and industrial wastes cause giant waste mountains near the residential areas. Another important problem that is caused by waste mountains is the pollution of underground water resources which are decreasing every other day in addition to the threat against public health.

The healthiest solution adopted by modern communities as well as our country is to collect the waste in waste disposal areas, treating leakage waters by draining, and discharging the methane gases or liquefying them to use them as energy. It is also possible to prevent the visual pollution by covering waste disposal areas which have fully utilized their capacities, with impermeable earth layer or with organic earth to turn them into green areas.

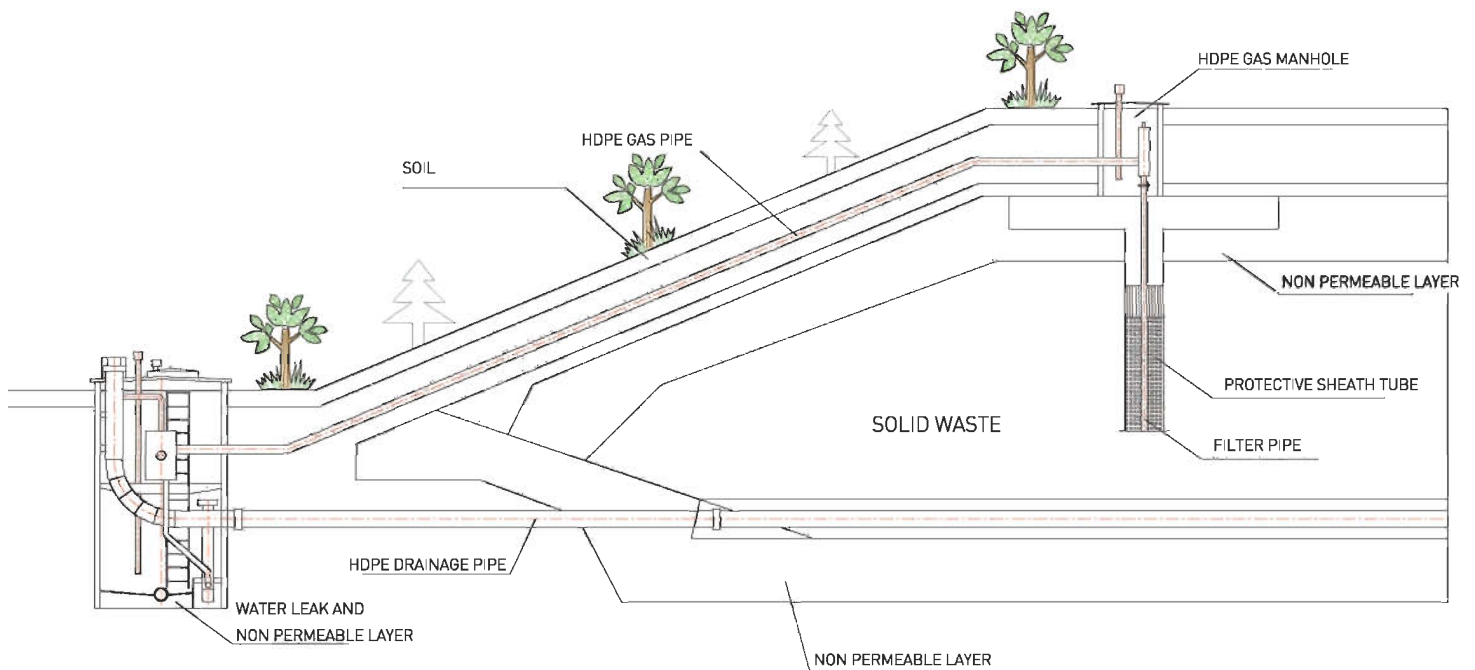

Solid wastes contain numerous chemical substances as well as lead and formation of many chemical substances through decomposition. This process takes long years. Therefore, the most ideal material is HDPE pipe which will show resistance against loads of garbage deposits and chemicals formed for extended years. FKS pipes which are used in either drainage of leakage water or methane gas discharges must be used securely in conditions required by DIN 16961. Laying conditions of the pipes to be used for drainage purpose and working systems and tests is conducted according to DIN 4266 standards.

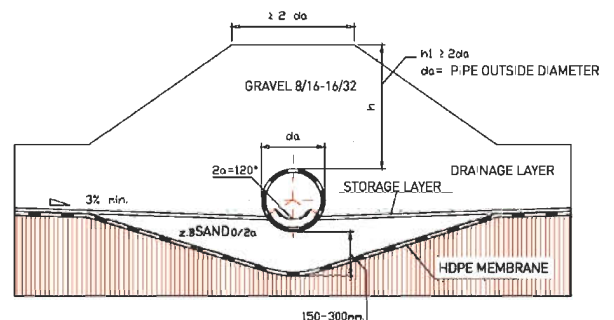

# Sewage

## Application Methods



### FKS Manhole and Application Method

It is also possible to produce cylindrical manholes and tanks up to 3.600 mm of internal diameter from FKS pipes. It is the healthiest solution especially for drainage water and gas collecting manholes in terms of system integrity in solid waste projects. It is the ideal product which provides ultimate tightness in joints of underground tanks, resting and sedimentation pool as well as corrosion resistance.

FKS system provides practical, economic and permanent solutions to the critical projects, since it has easy workability as well as appropriate to any kind of fusion methods.

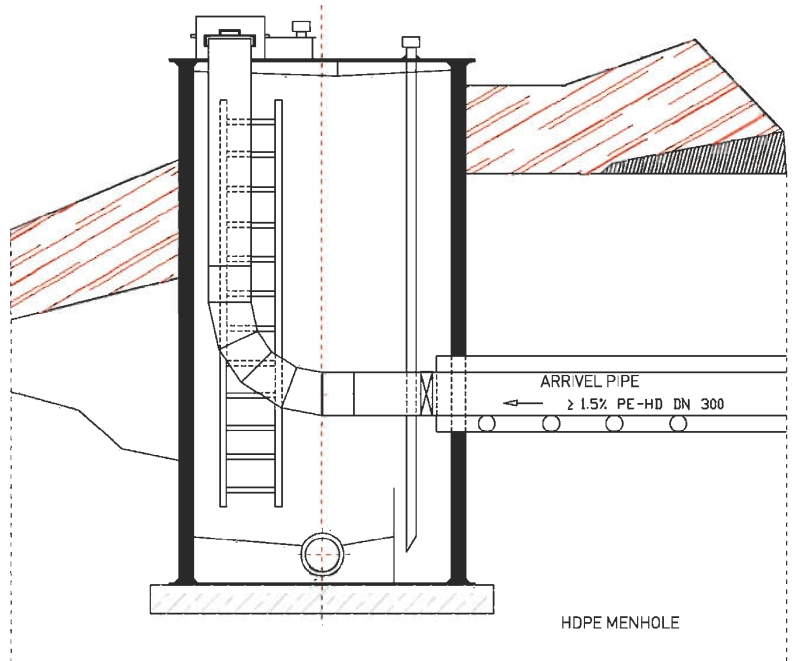

### Other Application of FKS Pipes

With FKS pipes, it is possible to carry out any kind of drainage operation beneath transportation lines such as public roads, railways as well as to perform any kind of level crossing applications in terms of road safety.



# FIRAT FKS Pipe and Fittings

- 1. Elbow, Y-branch and Reducers
- 2. Domestic Fittings
- 3. Manhole and Chimneys
- 4. Special Fittings

In the FKS pipe system, it is possible to produce any kind of pipe for the usage purposes of pipes, as well as ends of the fittings can be produced suitable to any kind of fusion methods as stated in pipe types. In this system, all fittings can be produced according to values specified in DIN 16961 standards. Special design and engineering production that are not contained in the standard are carried out by our company by calculating technical specifications for requested purposes.

## Elbow, Y-branch and Reducers

### FKS Elbows

In FKS pipe system, end parts of the elbows are produced suitable to various fusion methods according to pipe type and application areas. Standard elbow dimensions are specified in below table.

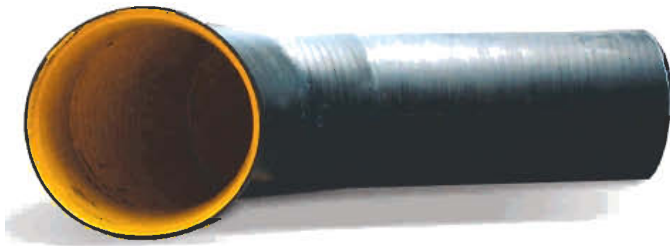

Nominal Diameter [mm.]	S [mm.]	l [mm.] Pieces of Segments					
		2	2	3	3	4	4
		a=15°	a=30°	a=45°	a=60°	a=75°	a=90°
300	Wall thickness value specified in the projects	100	190	230	280	330	410
400		160	210	270	330	410	510
500		170	235	310	390	490	600
600		180	270	350	450	560	700
700		200	300	400	510	550	820
800		210	320	430	560	720	900
900		220	340	470	620	790	1.000
1.000		240	380	520	680	870	1.100
1.100		250	400	560	750	950	1.200
1.200		270	430	600	800	1.020	1.300
1.300		300	460	640	860	1.100	1.400
1.400		330	490	680	920	1.180	1.500
1.500		360	520	720	980	1.260	1.600
1.600		390	650	760	1.040	1.340	1.700
1.800	420	580	800	1.100	1.420	1.800	
2.000	450	610	840	1.160	1.500	1.900	
2.000 -3.600	Project-specific dimensioning and special production						

Elbow Segment Dimensions According to DIN 16961 Standards

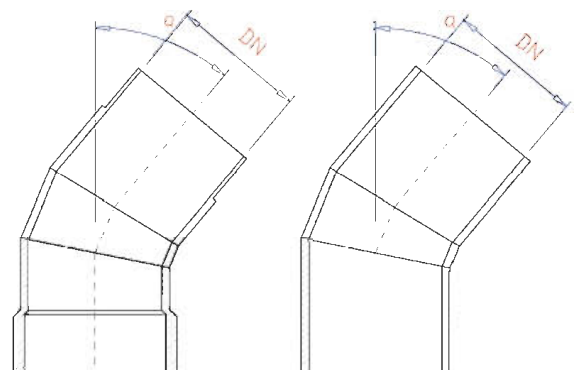

# FIRAT FKS Pipe and Fittings



## FKS Y-branches

In FKS pipe system, single or multiple y-branches at desired angles as well as end parts of the elbows are produced suitable for various fusion methods according to pipe type and application areas. Standard y-branch dimensions are specified in below table.

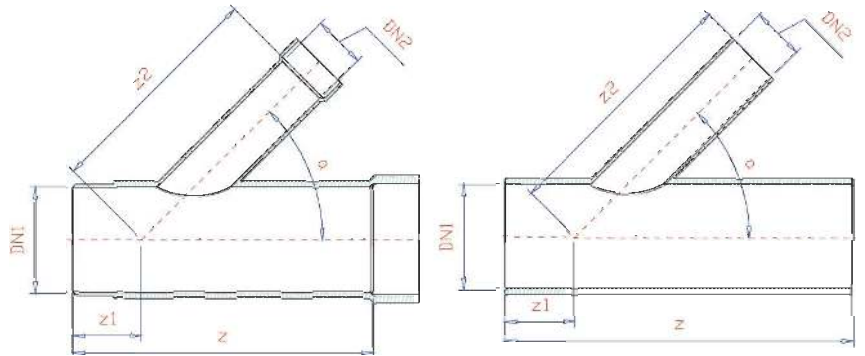

## Y-branch Segment Dimensions According to DIN 16961 Standards

Inner Diameter DN1 mm.	Outer Diameter DN2 mm.	Z mm.	Z1 mm.	Z2 mm.
300	100/150/200/250	1.100	350	750
400	100/150/200/250/300	1.300	400	900
500	100/150/200/250/300	1.400	400	1.000
600	100/150/200/250/300	1.650	450	1.200
700	100/150/200/250/300	1.900	500	1.400
800	100/150/200/250/300	1.900	500	1.400
900	100/150/200/250/300	2.000	500	1.600
1.000	100/150/200/250/300	2.000	500	1.600
1.100	100/150/200/250/300	2.100	500	1.600
1.200	100/150/200/250/300	2.100	500	1.800
1.300	100/150/200/250/300			
1.400	100/150/200/250/300			
1.500	100/150/200/250/300			
1.600	100/150/200/250/300			
1.800	100/150/200/250/300			
2.000	100/150/200/250/300			
2.000 -3.600		Project-specific dimensioning and special production		



**FKS Reducers**

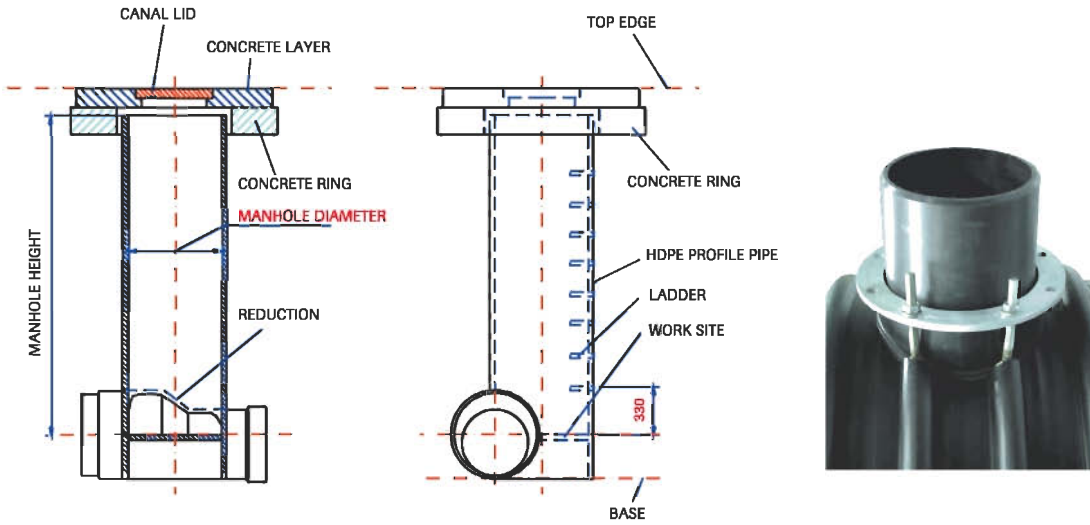

**Y-branch Segment Dimensions According to DIN 16961 Standards**

Outer Diameter mm. DN2	Inner Diameter mm. DN1	Reducer Length mm. L	t1	t2
300	400	350	500	500
	500	700	500	500
400	500	350	500	500
	600	700	500	500
500	600	350	500	500
	700	750	500	500
600	700	400	500	500
	800	750	500	500
700	800	350	500	500
	900	750	500	500
800	900	350	500	500
	1.000	750	500	500
900 - 3.400	1.000 - 3.600	Project-specific dimensioning and special production		

## FIRAT FKS Pipe and Fittings

### Manhole, Chimney and Tanks

Since FKS pipe system provides a complete solution, a complete reliable and practical solution is provided particularly to manhole and maintenance chimneys which are one of the biggest problems of Sewage projects with FKS system. The manhole and chimneys which will be used in the project are produced in Firat Facilities conforming to the project and they can be joined with the pipes like a normal pipe joining on the application site.



### FKS Pipe, Manhole and Chimneys

In the Sewage systems, manhole and chimneys are needed at control and return points of join points of various canals. Manholes can completely be produced from HDPE, including its top cover housings as well as top sections can be made up of concrete. Top cover systems of manhole and chimneys completely made up of HDPE can be produced telescopically. The biggest advantage of the covers which are produced as such is capability of adjusting manhole cover very practically according to road level when any change occurs in road level.

Manhole and chimneys can be assembled on the joining systems on the pipe entrance and exit points in accordance with project and very fast and easy assembly can be carried out on the construction site. Data on diameters, wall thickness of manhole and chimneys is determined according to load and ground water values of the application area. Concrete cover load of manhole and chimneys of which top cover is designed in concrete are transferred on the earth surrounding.

For secure control of manhole and chimneys of which internal sections can be produced in different colors, exit ladders, control step and dikes can be produced. No problems occur such as oxidization, leakages since bases of manhole and chimneys, entrance and exit joins are produced completely from HDPE.

In FKS Sewage system, two different manholes and chimneys are produced such as "entrance-exit and "tangent".



## Entrance – Exit Manholes

These types of manholes are especially suitable to return points which have more than two entrances and exits. These types of manholes are ideal for pipes with internal diameters from 300 mm to 700 mm. Manholes with ID 1000 mm diameter are suitable for pipes from ID 300 mm to 500 mm and Manholes with ID 1200 mm diameter for pipes from ID 600 mm to 900 mm. The base of this type of manholes is constructed by welding with HDPE or PP, therefore ensures ultimate tightness as well as it is possible to produce step and dike from same material on the base. Even though it is possible to produce concrete step or dike on the base made up of same material, this application is not advised so much.

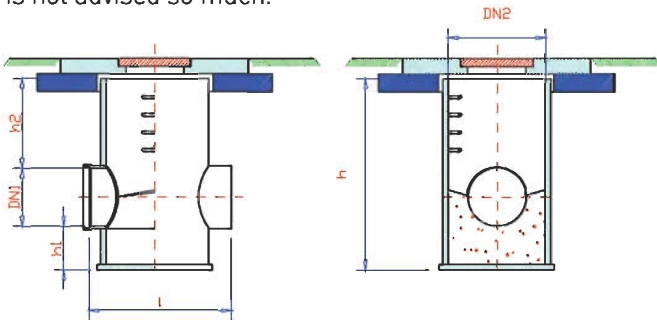

### Main Specifications of FKS Manholes and Chimneys

- Internal surfaces are produced in light (yellow) color for ease of control.
- It is far lighter than conventional applications.
- Can be produced with an internal diameter up to 3600mm.
- Have smooth internal and external surfaces.
- Pose no shipment and storage problems since they are built ready to apply on the construction site.
- Show high resistance against chemicals.
- Ensure ultimate tightness.
- Are not affected from seismic earth movements and earthquakes.
- Pressure losses arising from friction are minimal.
- Minimum useful life of 50 years.



At the returning point, manhole with entrance and exit, pipe inside dike and ladder applied.



Concrete manhole application



Concrete manhole application

# FIRAT FKS Pipe and Fittings

## Tangent Manholes

In FKS pipe system, the most economical and practical manhole application is tangible manholes for pipes with internal diameter of 800 mm. and above. In this type of application, standard manhole internal diameter is 1000 mm. assembled tangent to the centre of manhole pipe line.

In tangent manholes, also applications of HDPE telescopic cover or concrete cover can be carried out. With this manhole application, it is also possible to carry out healthy application in angled bends as well as straight pipelines.

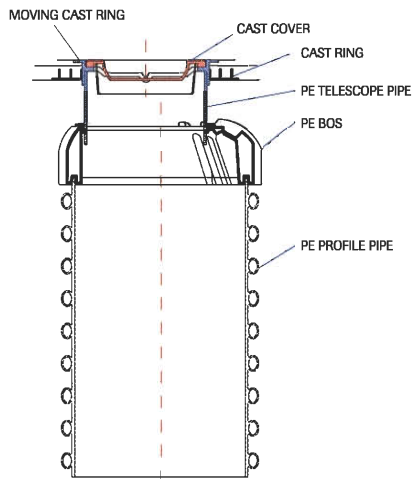

Tangent manhole application

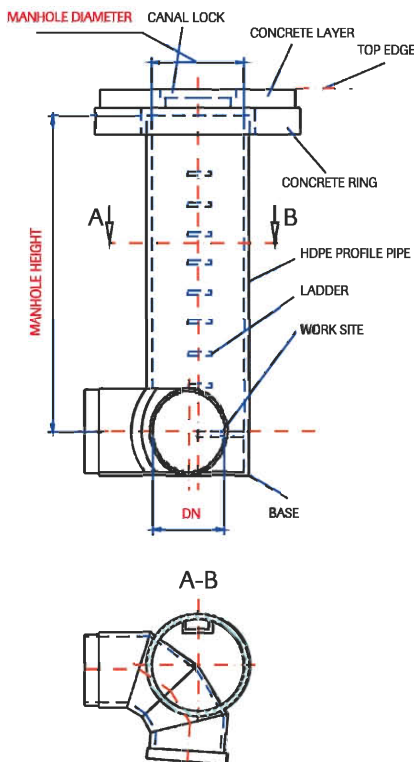

90° Transition Tangent Manhole

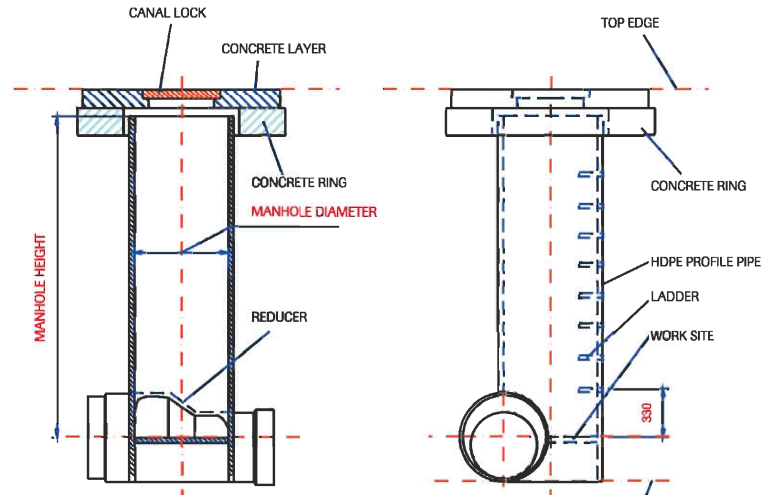

Manhole with reducer transition

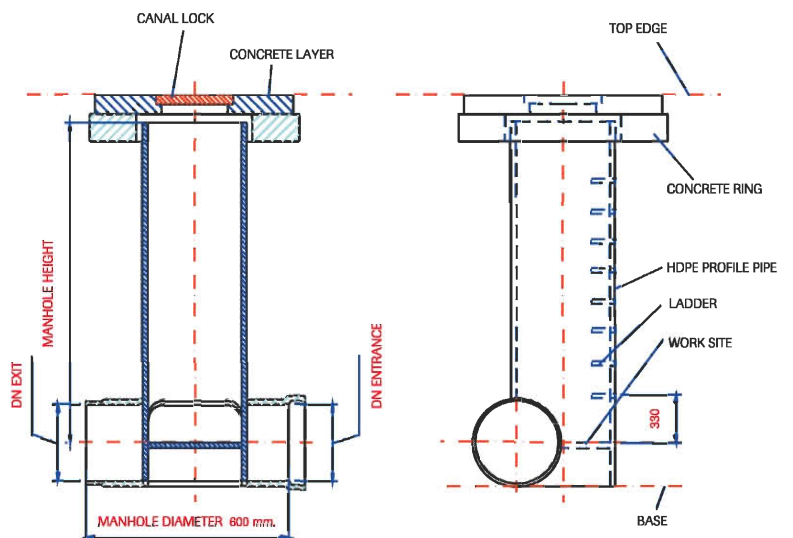

Tangent Manhole

### **FKS Tanks**

In FKS system, cylindrical, vertical and horizontal tank production is carried out from internal diameter of 300 mm up to 3600 mm. It is possible to join any kind of entrance and exit pipes, covers and valves to these tanks. FKS tanks are produced with capacities from 2000 up to 50.000 lt.

FKS tanks are durable against many chemicals due to the properties of their raw material and suitable for storage of any kind of liquid and solid food since they are completely hygienic as well. Internal and external surfaces of tanks are smooth and it is possible to make internal surfaces in different colors. While tanks produced from HDPE can have wall thicknesses from minimum 5 mm to maximum 100 mm, tanks made up of PP can have wall thickness from minimum 5 mm to maximum 80 mm.

Since FKS tanks produced from HDPE are in black durable against UV, they are suitable for use in any kind of external environment. Since PP tanks have lighter color, they are suitable for enclosed areas which are not under effect of direct sunlight.

### **Main Application Areas of FKS Tanks**

- Water tanks (especially interior water tanks).
- Storage of liquid foodstuff.
- Storage of grain and pulse.
- Processed tea and tobacco depots.
- Storage of industrial powder chemicals.
- Methane gas tanks of solid waste projects.
- Treatment facilities, process tanks.
- Storage of mineral oils.



Example of tank produced from PP



Example of tank produced from HDPE

## FIRAT FKS Pipe and Fittings

### Special Fittings

#### Special Fittings

FKS pipe system brings practical and economic solutions to all fittings and special joinings required for all projects without deteriorating system integrity and reliability. All fittings that must be used in the system are produced and joined with the same material.

#### Flange Adapter and Flanges

In FKS system, flanged transition system is used in demounted joins of either tank or manholes. In this system, flange adapters are produced from HDPE or PP. Flanges can be produced from stainless steel or galvanized steel as well as HDPE or PP-coated steel.

Joining of flange adapters to pipe or tanks can be made using butt welding or extrusion welding methods according the point to be joined. This operation can be carried out in production facilities and on the construction site or in the application area.

In large and critical projects, flange adapter can be integrated with FKS pipe and a flange can be mounted on it later.



**Concrete Transition Parts**

In Sewage systems, when manhole or chimney application is carried out, a special transition part must be used in order to ensure to fix the pipe to the concrete in a manner maintaining tightness and the pipe shall be welded to the pipe joint section of concrete.

Particularly in treatment facility applications, concrete transitions must be made with this method.

Concrete transition part can be in muff which is fitted through electro-fusion welding or as flange adapter suitable for flanged joining or through suitable to butt-welding, electro-fusion welding.

The most important feature of concrete transition part is that its ability to maintain impermeable connection of aggressively-structured concrete with the system. Specially designed external surface of this part maintains the connection which will provide the ultimate impermeability with the concrete. Concrete transition part is placed in concrete mold during concrete application.



**Other Special Parts**

In FKS system, it is also possible to design and produce several engineering part used inside the system in addition to standard parts specified above.



## **FKS Pipe Storage Shipping Methods**

FKS pipes and manholes require attention during storage and shipment and handling due to the nature of their rawmaterial. Since they are made of elastic materials, they may be damaged due to hard impacts rather than falling and overturning. Therefore, below points shall be observed during storage, loading and shipment of FKS pipes.

### **FKS Pipe Storage Methods**

- FKS pipes must be stored in the areas protected from direct sunlight, if possible covered with shelter. Storage can be made indefinitely in such an environment.
- Avoid storage for extended periods in completely covered hot areas.
- Maximum storage time is one year in environments directly exposed to sunlight.
- Storage area floors must be smooth and free of sharp materials such as pointed stones etc.
- Since the raw material of FKS pipes is flammable, necessary safety measurements must be taken during storage.
- In telescopic storage, not more than one pipe must be placed one on another. In stacking type storage, pipes must not be placed telescopically.
- The pipes at 600 mm diameter can be stacked crosswise to form a maximum number of three rows. While stacking, pipe muffs must be placed in alternating directions.
- Pipes with diameters between 600 and 1000 mm can be stacked crosswise for a maximum number of two rows. While stacking, pipe muffs must be placed in alternating directions.
- Pipes with diameter above 1000 mm can be stored for single row and must not be stacked on each other.



Teleskobik stoklama



Stack storage



### FKS Pipe Shipping Methods

- Electro-fusion welding fitted muff sections and spigot ends of FKS pipes are packed to prevent contamination. Attention shall be paid not to deteriorate the packages during shipment to keep them clean during welding.
- FKS pipes are at the length of 6 m as a standard and can be shipped as 12 m by welding two pipes in the factory.
- By placing pipes telescopically, great shipment savings can be achieved.
- During loading and placing the pipes inside the trench, they must be protected from sharp impacts and lifted with a textile rope through a sling from both sides.
- In lifting operations carried out by heavy-duty machines, suspension rope must always be used. While loading with forklifts, arms of the lift truck must be placed inside the pipe by keeping forklift arms long, avoiding hard strikes and grinding. In this lifting type, attention shall be paid that pipe does not suspended from its single end which will cause tearing the pipe.
- Since end sections of pipes are produced sensitively in particular in terms of dimension, damages during loading shall be avoided in order to prevent problems during welding and they must be leaned against the end section of vehicle casing slowly.
- While loading open box vehicles, necessary measures shall be taken to prevent damaging the pipe with side supports; centre and end sections must be strengthened and tied with textile rope to prevent pipes from sliding.
- Pipes shall never be handled by dragging on the ground and shall be carried by toppling over the smooth grounds without causing any damage.
- In telescopic loading, while inserting smaller diameter pipe into larger diameter pipe, attention shall be paid not to cause friction and muff sections must be placed in alternative directions. Pay particularly attention not to damage welding resistors.
- In stacked loading, muff sections of pipes must be placed on the vehicle in a zigzag manner. In the projects where different diameters will be applied, use of pipes with diameter pipes by applicators in the same time will enable the telescopic loading, providing great advantage in terms of transportation. While preparing the construction site schedule, this issue must be taken into account.



# FKS Pipe Calculation Methods

All calculations of FSC pipes are performed according to work conditions in the projects to be applied as well as relevant DIN and ATV norms.

## Ring Rigidity Calculation

Ring rigidity calculation, the strength calculations of FKS pipes against external loads are performed according to the ATV 127 standard and tests according to the DIN 16961 standard. As a rule, durability test is calculated 2 times. The acceptable deformation rate is 6%. This calculation method is carried out according to ATV 127 standard

### Calculation method according to ATV 127

$$S_{R24} = \frac{E_{C24} \cdot I}{r^3}$$

- EC** : Elasticity Modulus
- I** : Moment of Inertia
- r** : (DN/2) + neutral linear radius at e  
(e: Distance of inertia of the pipe profile)

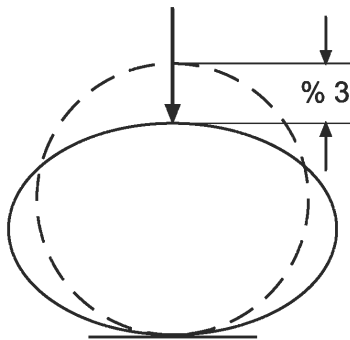

### Minimum Elasticity Module Values (kN/m<sup>2</sup>)

Test time	HD-PE	PPH Homopolymer	PPR Copolymer
24 h Ec24	3.9 x 10 <sup>5</sup>	6.9 x 10 <sup>5</sup>	4.4 x 10 <sup>5</sup>

## Hydraulics Calculation

Since internal surface roughness is very little in FKS pipes, fluidity values are very high. Therefore, very little slope arrangement (0.015%) is sufficient in Sewage lines built with FKS pipe.

This feature provides great advantage in terms of excavation for longer lines.

Hydraulics calculation of FKS pipes is carried out according to ATV-110 standard. Yet, hydraulics calculations must be carried out by considering complete or incomplete filling rates of pipe.

The calculation of Hydraulics (operating smoothness) must be carried out as specified in ATV standard by considering the flow losses inside the pipe, manhole and fittings.

The fluidity kb value of the system consisting of FKS pipe, fitting and manhole must be taken as 0.1 mm.



**Calculation of Operating Smoothness Kb**

Calculation of operating smoothness is performed with the formula of maximum flow rate (v) PRANDTL and COLEBROOK.

$$V = \left( -2 \cdot \log \left[ \frac{2.51 \cdot v}{d \sqrt{2 \cdot g \cdot J_e \cdot d}} + \frac{k_b}{3.71 \cdot d} \right] \right) \cdot \sqrt{2 \cdot g \cdot J_e \cdot d}$$

- v** : Flow rate (m/s)
- Je** : Centric tendency of power line (-)
- Kb** : Operating smoothness (mm.)
- g** : Gravity acceleration (Nm/s<sup>2</sup>)
- √** : Kinematic hardness (1.31x10<sup>-6</sup> for waste water at 12 °C) (m<sup>2</sup>/s)
- d** : Pipe internal diameter (mm.)

**Maximum, complete fullness flow rate (Q):**

$$Q = v \cdot A$$

- Q** : Debl (l/s)
- A** : Cross-sectional area (mm<sup>2</sup>)

**Surface Smoothness (Kb) values of operating environments calculated by considering load losses**

Operating Types	Kb recommended for HDPE	Kb specified in ATV-A110 standard
Reducer-type lines, pressurized lines, relining replenishment lines without manhole.	0.10 mm.	0.25 mm.
Side lines joined with manhole.	0.25 mm.	0.50 mm.
Manhole-joined collector lines according to ATV A 241 1.1.5	0.50 mm.	0.75 mm.
Additional entrance lines and collecting canals; special manholes with angled slopes according to ATV-A 241.1.15	0.75 mm.	1.5 mm.

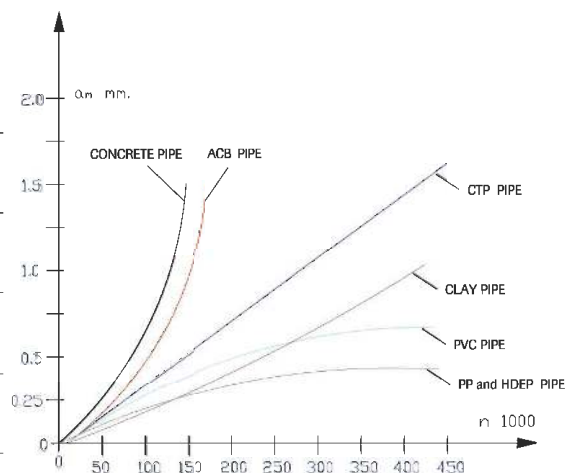

German Darmstad Institute Pipes, Abrasion Curve

# FKS Pipe Calculation Methods

## Flow Rate for partially filled pipes

In partially filled pipelines, it is difficult to calculate the fluidity. Because, filling height cannot be known in partially filled pipelines. But assuming that pipe lines are straight with slight slope in Sewage lines and water surface inside the pipe flows parallel to pipe bottom, the rates of partial fill value to the complete fill value are taken as a basis.

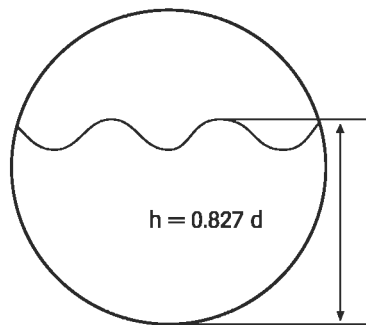

Partial filling condition in Sewage line in terms of ventilation or inflow problem:  $hT/d = 0,827$ .

When calculating the filling height ratio ( $hT/d$ ), it must be ensured that filling height  $hT$  is measured according to pipe axis.

$$\frac{V_T}{V_V} = \left( \frac{R_{hy, T}}{R_{hy, V}} \right)^{0.625}$$

$V_V$  : Flow rate at full filling     $V_T$  : Flow rate at partial filling

$$R_{hy, T} = \frac{A}{Lu}$$

$Lu$ : Partial circumference,  $R_{hy, T}$ : Hydraulic radius in partial filling  
 $A$ : Partial flow surface

$$R_{hy, V} = \frac{d}{4}$$

$d$ : Internal diameter  $R_{hy, V}$ : Hydraulic radius in full filling

$$\frac{Q_T}{Q_V} = \frac{A_T}{A_V} \cdot \left( \frac{R_{hy, T}}{R_{hy, V}} \right)^{0.625}$$

$Q_T$ : Flow rate at partial filling     $A_T$ : Partial flow surface

**Static Calculation**

Since FKS pipes made of HDPE or PP are generally laid underground, they are subjected to several loads. In a healthy pipe design, static calculations must be made correctly according to ATV A-127 norms. In order to make the calculation correctly, the application area of pipe and pipe work conditions must be known precisely.

**Weight Average of Vehicles According to ATV 127**

Vehicles	Entire Weight KN	Wheel Load KN	Load Above Wheel		Loads on the Pipe front back
			Width (m.)	Length (m.)	
SLW 60	600	100	0.6	0.2	• Traffic load (street).
SLW 30	300	50	0.4	0.2	• Traffic load (train).
SLW 12	120	ön 20	0.2	0.2	• Top filling earth load.
		arka 40	0.3	0.2	• Construction site load.
					• Underground water pressure.

The loads to which Sewage pipes are subjected to are mainly top filling, earth load and traffic load. When calculating the traffic load of all trenches, ATV user's manual, A 127 norm shall be observed and it must be accepted that LKW 12 traffic load is present.

**Stability Calculation**

The pipes laid underground are subjected to other loads in addition to the earth load. These are additional loads such as ground water loads for underground pipelines and sea discharge for underwater pipelines. Stability must be calculated for lining concrete to fill the gaps between pipes for telescopic pipes or for extremely stressed projects such as additional loads formed in pipes operated with vacuuming.

Stability calculations for FKS pipes:

$$P_k = \frac{10 \cdot E_c}{4 \cdot (1 - \mu^2)} \cdot \left( \frac{s}{r_m} \right)^3$$

P<sub>k</sub> : Critical stability pressure (bar)  
 E<sub>c</sub> : Elasticity modulus (N/mm<sup>2</sup>)  
 μ : Constraint Transversal thermoplastic (0.4)  
 s : Wall Thickness (mm.)  
 r<sub>m</sub> : Average pipe radius (mm.)

Admissible stability calculation for FKS pipes:

$$P_{k, zul} = P_k \cdot \frac{fr}{S}$$

P<sub>k, zul</sub> : Admissible critical stability pressure (bar)  
 fr : Reducing factor (0.9 ... 0.95) (-)  
 S : Safety factor (2) (-)

Calculation of stability tension for FKS pipes:

$$\acute{O}_k = P_k \cdot \frac{r_m}{S}$$

Ó<sub>k</sub> : Stability (tension) (N/mm<sup>2</sup>)  
 P<sub>k</sub> : Critical stability pressure (bar)  
 S : Wall Thickness (mm.)  
 r<sub>m</sub> : Average pipe radius (mm.)

# FKS Pipe Calculation Methods

## Buoyancy and Concrete Support Calculation

FKS Pipes must be anchored with concrete clamps for underwater application such as sea discharge or extremely high groundwater for underground applications in order to protect pipes from buoyancy of water. In calculation of the assembly intervals of said concrete clamps, it should be ensured that pipes will not be bent due to buoyancy of water.

Stability calculations for FKS pipes:

Filled pipe calculation formula

$$F_v = \left( \frac{\pi \cdot d_a^2}{400} \right) \cdot \gamma_D - 1$$

Empty pipe calculation formula

$$F_v = \frac{DN^2 \pi}{400} \cdot L_R \cdot \gamma_D$$

$F_v$  : Lifting force (N)  
 $d_a$  : Pipe external diameter (mm.)  
 $DN$  : Pipe internal diameter (mm.)  
 $\gamma_D$  : Specific density of lining (kg/dm<sup>3</sup>)  
 $L_R$  : Support interval (m.)

Maximum support (concrete clamp) distance:

$$L_A = f_{LA} \cdot \sqrt[3]{\frac{E_C \cdot J_R}{q}}$$

$L_A$  : Maximum support dis. (mm.)  
 $f_{LA}$  : Bending factor (0,80) (-)  
 $E_C$  : Elasticity modulus (N/mm<sup>2</sup>)  
 $J_R$  : Moment of Inertia of the pipe (mm<sup>4</sup>)  
 $q$  : Lifting load (N/mm.)

### Longitudinal Elongation Calculation Due To Heat Variability

When FKS pipes made of HDPE and PP raw material are used in hot water transfers for industrial purpose, heat expansion and elongation by length occurs.

In this type of projects, expansion calculation shall be made according to the below formula by taking the heat value of liquid to be carried into account.

#### Expansion Coefficient of Some Plastic Raw material

$$\Delta L = \alpha \cdot L \cdot \Delta T$$

$\Delta L$  : Flexion rates against heat changes (mm)

$\alpha$  : Linear expansion coefficient (mm./m.K)

L : Pipe length (mm.)

$\Delta T$  : Hear difference (K)

$\Delta T$  value is calculated by subtracting estimated heat value during work from maximum environment heat during laying.

#### Expansion Co-efficient of Some Plastic Raw material

Material Type	Linear Expansion Coefficient $\alpha$
(HDPE) High Density Polyethylene	0.18
(PP) Polypropylene	0.15
(PVDF) Polyvinyliden chloride	0.14
(PB) Polybutadiene	0.12
(PVC) Polyvinylchloride	0.07
(CTP) Fiberglass reinforced plastic	0.02

## Do's and Don'ts in FKS Pipes and Fittings

Since FKS pipes are designed to have complete durability against external loads which does not contain high hydrostatic pressure, their main areas of application are the projects which require gravity flows such as Sewage and sea discharge.

In order to obtain required efficiency from every project designed, the pipes to be used in the application and application essentials must be known very well. Therefore, during project stage as well as application, system must be evaluated as a whole by considering all details. Because FKS pipes provide lasting and substantial solutions for the projects without impairing system integrity.

- 1 In order to carry out a sound compaction, trench width must be minimum 100 cm larger than pipe's external diameter. So, the pipe centered on the trench will have a minimum  $A2=50$  cm distance to both sides of the trench.
- 2 Base filling under pipe must have a minimum height of  $A1= OD/ 10 + 10$  cm from trench bottom. (However  $A1$  is min. 15 cm). (OD: Pipe external diameter). Material to be used in the filling must be the material, diameter of which is 0-20 mm and compactable, with maximum 20% moisture content. This material must be compacted at 90% as minimum with a compactor before placing over the pipe. (EN 1610). Filling material of trench ground must be durable, stable and must have sufficient carrying capability which will prevent damaging the pipes.

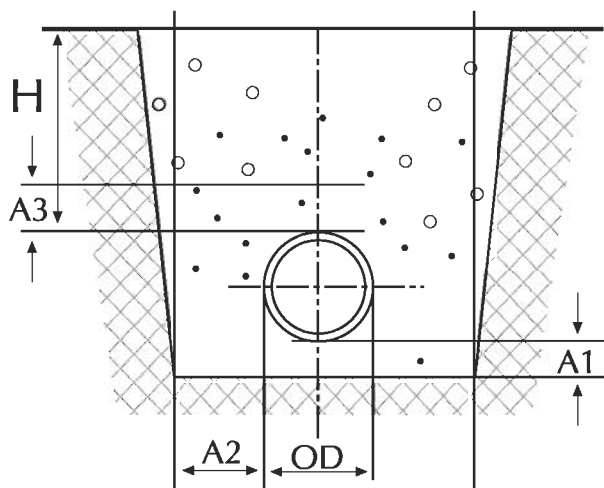

Placement of Pipe in the Trench

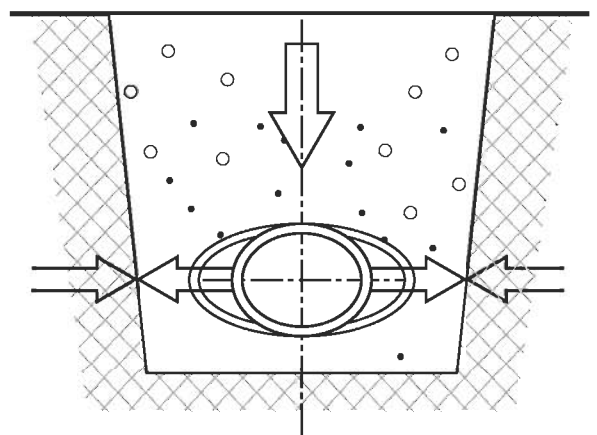



- 3 In the cases where ground conditions are inadequate, according to the need of trenches basin, it can be improved with geo-textile, oversize gravel/crushed stone, reinforced concrete bedding or a combination of them and also with sufficient compaction.
- 4 While filling the sides, there must be a minimum gap of 50 cm enabling compact working comfortably between pipe and trench wall. Side filling must be compacted with a compactor with 95% compaction rate every 30 cm of filling following the ground filling, as stated above. Filling operation must be repeated with the same material until reaching top of the pipe.  
(Relevant Standard ATV A 127 and EN 1610).



# Order Specifications Sample and Comparison Table

## HDPE Spiral Wound Sewage and Rain Water Drainage Pipes Technical Specifications (Draft)

### 1. Scope

These specifications define technical and physical properties of spiral wound profiled pipes made of HDPE, to be use in gravity Sewage and rain water drainage lines.

### 2. General Conditions

Only companies which have the ISO 9001 Quality Management System certificate are eligible to bid in tender initiated by Procurement Agency. HDPE spiral wound pipes must have the properties which will meet the requirements of TS 12312 standard. TS 12132 certificate given by TSE Agency will be submitted together with proposal.

Proposals of the companies which did not submit the ISO 9001 and TS 12132 quality compliance certificates and certificate of manufacturing competence will not be evaluated.

### 3- Definitions

**Electro-fusion Welding:** The welding method where HDPE is melted and fused by means of applying current to resistor wires in order to join the pipes.

**Ring Rigidity:** The strength against loads pressed on the pipes (earth, static load, dynamic load, vacuum pressure).

### 4. Technical Specifications

#### 4.1 Surface Quality

Outer surface of HDPE pipes will be black in order to maintain strength against ultraviolet beams; inner surface will be yellow color. Color will be homogenous across the pipe and pipe end cutting points will be smooth and burr-free.

#### 4.2 Fusion

HDPE spiral wound pipes will be equipped with wires for electro-fusion welding and packaged in order to protect welding places against external effects.

#### 4.3 Dimension and Tolerances

Diameter dimensions and tolerances of pipes will meet the requirements of TS 12132 Standard.

Useful length of HDPE pipes will be 6 m. Length tolerance will be between +50 and -0 mm.

**5. Inspection and Tests**

**5.1 Rawmaterial Tests**

**Material Specifications of Pipes**

Specifications	Target Value	Test Method
Material type	HDPE	
Outer wall colour	Black	
Inner wall colour	Yellow	
Raw material density	> 0,940 gr/cm <sup>3</sup>	ISO 1183
Melting flow rate (190 oC/5 Kg.)	0,4 - 1,3 gr/10 dk	ISO 1133

**5.2 Pipe and Fittings Tests**

**Pipe Specifications**

Specifications	Target Value	Test Method
Ring Rigidity	24 h / max % 3 Stability	TS 12132 DIN 16961
Tightness	0,5 bar / 15 dk. Non-leaking	TS 12132 DIN 16961

**Below tests on HDPE spiral pipe and fittings inspection and acceptances will be conducted in the laboratories of producer.**

**5.2.1 Ring rigidity test:**

When ring rigidity test is conducted according to TS 12132 standard Article 2.3.3, internal diameter deformation value must be max 3% at the end of 24 hours.

**5.2.2 Tightness Test:**

When tested under 0.5 bar 15 min conditions according to joins welded with electro-fusion method according to Article 2.3.1.3 of TS 12132 Standard, no leakage shall occur at the end of period.

# Order Specifications Sample and Comparison Table

HDPE Pipe and Spiral Wound U-PVC Pipe Comparison Table Spiral HDPE

Comparison	Spiral HDPE	U-PVC
Service life (year)	98	50
Fragility	Durable	Not-durable
Standard length (m)	6 - 13	Free
Corrosion strength	Very durable	Partially durable
Raw material	Only HDPE	U-PVC and Galvanized band to increase durability
Joining type (connecting)	Electro-fusion Welding	Adhesive Sleeve
Ease of installation	Easy	Difficult
Experienced personnel	Not required	Required
Filling material measurement	Can be between 0-33 mm	20 mm is required
Filling material type	Every compactable material	Crushed stone- chips
Compaction	% 95	% 100
Hygienic superiority	Perfect	Insecure
Wall smoothness coefficient	0.007	0.1
Chemical resistance	Perfect	Partially durable
Number of wall	Double wall	Single wall
Rated diameter	Internal diameter	External diameter
Elongation coefficient	Extendable for 6 times	Not elongates, breakable
Test easiness in the construction site	Easy	Problematic
Repairable	Very Easy	Non-Repairable
Joining safety (0-100)	% 100	% 50
Joining time (600 mm and above)	15-20 minutes	60-90 minutes
Efficiency in watery ground	Perfect	Not used (no initial fusion with adhesive)
Tightness	% 100	% 60

- Due to production method of U-PVC Pipe, there are grooves in every 15-20 cm along the pipe. These grooves cause clogging due to the solid waste in Sewage systems in the course of time.
- In case of using the same pipe for rain water, stone or other parts coming along with rain water causes break of pipe wall. U-PVC Pipe does not elongate, because profile breaks at fitting places.
- Internal diameter of HDPE Pipe is 150 mm and 136 mm for U-PVC Pipe.
- PVC raw material and galvanized steel band reacts differently against earth load acting on U-PVC Pipe. The stretching coefficients of steel and PVC are different.
- Galvanized steel band loses its carrying property due corrosion in the course of time.
- The remaining partial pipes of HDPE Pipes can be used again. In U-PVC Pipes, they are scrapped as loss.
- In projects, 90 % HDPE Pipes and 10% U-PVC Pipes are preferred.
- Since in large diameter U-PVC Pipes, carrying capacity of steel bands at pipe end sections decreases, muff must be taken into protective concrete.
- In HDPE Pipes, the loss is zero in loading, unloading and handling inside construction site. In U-PV Pipes, 5% loss occurs in handlings in the construction site.

# FKS Pipe and Manhole Information Request Form

In order to help you in selection of suitable materials in your projects, please complete and submit us attached question forms according to your demands.

## FKS Pipe Information Request Form\*

### 1. PROJECT

Project Date : \_\_\_\_\_

Construction Site address: \_\_\_\_\_

Project Implementing Company: \_\_\_\_\_

Project Executive : \_\_\_\_\_

Phone: \_\_\_\_\_ Fax: \_\_\_\_\_

### 2. FKS PIPE

FKS Profiled canal pipe : \_\_\_\_\_ Pipe internal diameter: \_\_\_\_\_ mm.

Extruded spiral pipe : \_\_\_\_\_ Pipe external diameter: \_\_\_\_\_ mm.

\_\_\_\_\_ Wall thickness (s): \_\_\_\_\_ mm.

Pipeline length : \_\_\_\_\_ m.

Pipe rawmaterial :  HDPE  PP  PE-el

### 3. PIPE LOADS

Flowing materials : \_\_\_\_\_

Density : \_\_\_\_\_ g/cm<sup>3</sup>

Average temperature : \_\_\_\_\_ In the plant (TB) : \_\_\_\_\_ °C

\_\_\_\_\_ Maximum (Tmax) : \_\_\_\_\_ °C

Operating pressure (pü) : \_\_\_\_\_ bar (if not, without pressure)

Usage Time : \_\_\_\_\_ 50 yıl \_\_\_\_\_

Traffic load :  Not  SLW 60  SLW 30  LKW 12

\_\_\_\_\_ (600 kN) \_\_\_\_\_ (300 kN) \_\_\_\_\_ (120 kN)

Other loads : \_\_\_\_\_ N/mm<sup>2</sup> \_\_\_\_\_

Underground water height: \_\_\_\_\_

Collector : \_\_\_\_\_ mm.

Other details :  Yes  No

\* Question Form for technical calculations of Sewage Pipes according to ATV 127 Standard

# FKS Pipe and Manhole

## Information Request Form

### 4. PRODUCTION

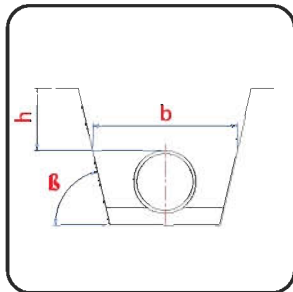

Trench Digging : Trench width (b) : \_\_\_\_\_ mm.  
 Trench slope (B) : \_\_\_\_\_  
 Filling height (h) : \_\_\_\_\_ mm.

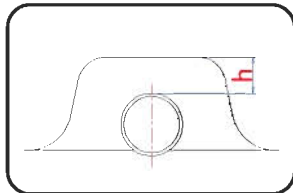

Height of Soil on the Pipe (h) : \_\_\_\_\_ mm.

#### Pipe Laying Conditions

Top Filling	Bedding
<input type="checkbox"/> A1	<input type="checkbox"/> B1
<input type="checkbox"/> A2	<input type="checkbox"/> B2
<input type="checkbox"/> A3	<input type="checkbox"/> B3
<input type="checkbox"/> A4	<input type="checkbox"/> B4

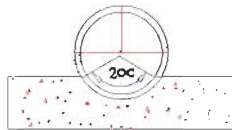

Tilting Degree  $20^\circ$  :  120°  180°

Note: Advised 180° Others : \_\_\_\_\_

### 5. GROUND

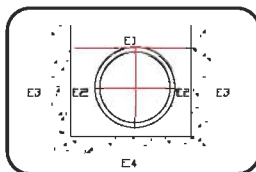

Land Structure Group	Region	E1	E2	E3	E4
----------------------	--------	----	----	----	----

G 1- Not adhesive (sand, gravel)	G1 <input type="checkbox"/>	G1 <input type="checkbox"/>	G1 <input type="checkbox"/>	G1 <input type="checkbox"/>
G 2 Low adhesive (sand, gravel)	G2 <input type="checkbox"/>	G2 <input type="checkbox"/>	G2 <input type="checkbox"/>	G2 <input type="checkbox"/>
G 3 -mixed land adhesion, deteriorated mud	G3 <input type="checkbox"/>	G3 <input type="checkbox"/>	G3 <input type="checkbox"/>	G3 <input type="checkbox"/>
G 4 -clay, slime	G4 <input type="checkbox"/>	G4 <input type="checkbox"/>	G4 <input type="checkbox"/>	G4 <input type="checkbox"/>

Foot Note: (E2) in conductive zone

Due to G1, sand must be used.

Density gB g/cm<sup>3</sup>

Compaction degree % 85 - % 100, % Dpr

Requirement  $\geq$  % 97

E-Module N/mm<sup>2</sup>

# FKS Manhole and Tank Information Request Form\*

## 1. PROJECT DETAILS

Project Date : \_\_\_\_\_  
 Construction Site address: \_\_\_\_\_  
 Project Implementing Company: \_\_\_\_\_  
 Project Executive : \_\_\_\_\_  
 Phone: \_\_\_\_\_ Fax: \_\_\_\_\_

## 2. PRODUCTION DETAILS

Manhole internal diameter : \_\_\_\_\_ mm.  
 Production height (h1) : \_\_\_\_\_ mm.  
 Manhole pipe length (h2) : \_\_\_\_\_ mm.  
 Underground water height (hw): \_\_\_\_\_ mm.  
 Work width (bA) : \_\_\_\_\_ mm.  
 Filling material density : \_\_\_\_\_ g/cm<sup>2</sup>

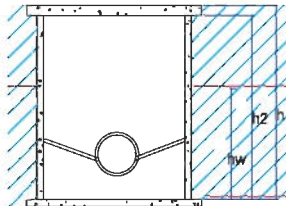

Manhole rawmaterial :  HDPE  PP

## 3. LAND STRUCTURE

Land	Bedding		Remaining part			
Ground Group	<input type="checkbox"/> G1	<input type="checkbox"/> G2	<input type="checkbox"/> G1	<input type="checkbox"/> G2	<input type="checkbox"/> G3	<input type="checkbox"/> G4
Compaction Density	_____		_____			
(Proctor Density)	_____ %		_____ %			
Elasticity Module	_____		_____			
E-Module	_____ N/mm <sup>2</sup>		_____ N/mm <sup>2</sup>			

## 4. TRAFFIC LOADS

	On the Cover	Manhole Cover-Side
Traffic Load None:	<input type="checkbox"/>	<input type="checkbox"/>
SLW 30:	<input type="checkbox"/>	<input type="checkbox"/>
SLW 60:	<input type="checkbox"/>	<input type="checkbox"/>
Other Details:	_____ kN	

\* Question Form for technical calculations of HDPE Manholes according to ATV 127 Standard

# FKS Manhole and Tank

## Information Request Form

### 5- MANHOLE COVERS

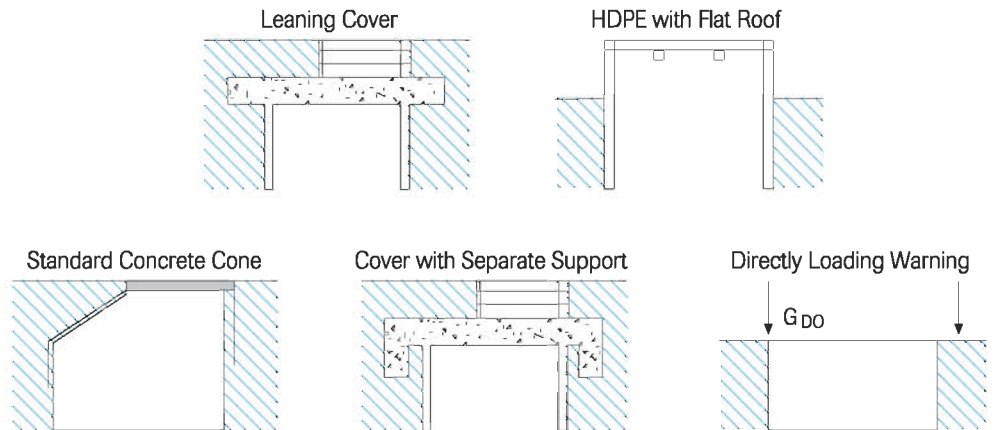

### 6- BASE PLATES

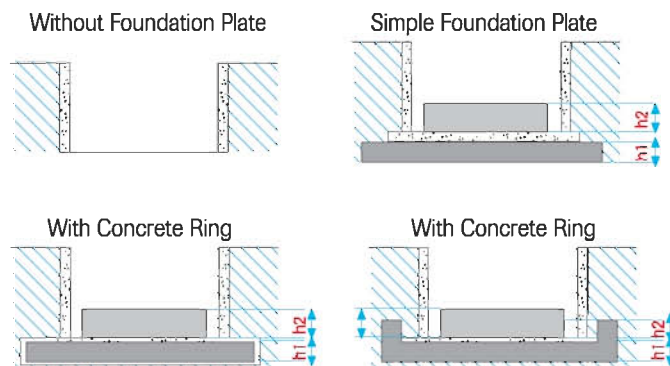

### 7- ENTRANCE- EXIT PIPES

Pipe Insertions	Diameter	Wall Thickness	Position
1. Pipe Insertion	mm.	mm.	°
2. Pipe Insertion	mm.	mm.	°
3. Pipe Insertion	mm.	mm.	°
4. Pipe Insertion	mm.	mm.	°
5. Pipe Insertion	mm.	mm.	°

### 8- BASE PRODUCTION FEATURES

Concrete Base Plate Thickness (hb) \_\_\_\_\_ mm.

Concrete Base Plate Diameter \_\_\_\_\_ mm.

Concrete Quality of Concrete Plate \_\_\_\_\_ mm.

Height of Concrete Seat \_\_\_\_\_ mm.

Concrete Filling Height \_\_\_\_\_ mm.



# FKS Pipe

## Pos Numbers

FKS pipes have all the certificates proposed by relevant standards concerning rawmaterial or product as well as certificates for controls carried out by independent test and auditing firms.

### FKS Pipes Public Works Pos. Numbers 04-468/7

Pipe Internal Diameter (mm)	Pipe Types						1.600	A	B	C	D	E	F
	Type 2	Type 3	Type	Type 5	Type	Type 7							
400	A	B	C	D	E	F	1.800	A	B	C	D	E	F
500	A	B	C	D	E	F	2.000	A	B	C	D	E	F
600	A	B	C	D	E	F	2.200	A	B	C	D	E	F
700	A	B	C	D	E	F	2.400	A	B	C	D	E	F
800	A	B	C	D	E	F	2.600	A	B	C	D	E	F
900	A	B	C	D	E	F	2.800	A	B	C	D	E	F
1.000	A	B	C	D	E	F	3.000	A	B	C	D	E	F
1.100	A	B	C	D	E	F	3.200	A	B	C	D	E	F
1.200	A	B	C	D	E	F	3.400	A	B	C	D	E	F
1.400	A	B	C	D	E	F	3.600	A	B	C	D	E	F

### FKS Pipes Provincial Bank Pos. Numbers

Pipe Internal Diameter (mm)	Boru Tipleri					
	Type 2	Type 3	Type 4	Type 5	Type 6	Type 7
150	-	-	-	12,2201	-	-
200	-	-	-	12,2202	-	-
300	-	-	-	12,2203	-	-
400	-	-	-	12,2204	-	-
500	12,2205	12,2231	12,2245	12,2256	12,2270	12,2281
600	12,2206	12,2232	12,2246	12,2257	12,2271	12,2282
800	12,2208	12,2233	12,2247	12,2258	12,2272	12,2283
1.000	12,2210	12,2234	12,2248	12,2259	12,2273	12,2284
1.200	12,2212	12,2235	12,2249	12,2260	12,2274	12,2285
1.400	12,2214	12,2236	12,2250	12,2261	12,2275	12,2286
1.600	12,2216	12,2237	12,2251	12,2262	12,2276	12,2287
1.800	12,2218	12,2238	12,2252	12,2263	12,2277	12,2288
2.000	12,2220	12,2239	12,2253	12,2264	12,2278	12,2289
2.200	12,2222	12,2240	-	12,2265	-	-
2.400	12,2224	12,2241	-	12,2266	-	-
2.600	12,2226	12,2242	-	12,2267	-	-
2.800	12,2228	12,2243	-	12,2268	-	-
3.000	12,2230	12,2244	12,2255	12,2269	12,2280	-

**Notes:**

Interim diameters will be found with interpolation.

Head tying pos. (ef welding) 12.2301

Polyethylene inspection chimneys pos. starts from 12.2401/1.

# FIRAT sells to a lot of Countries in Europe, Asia and Africa

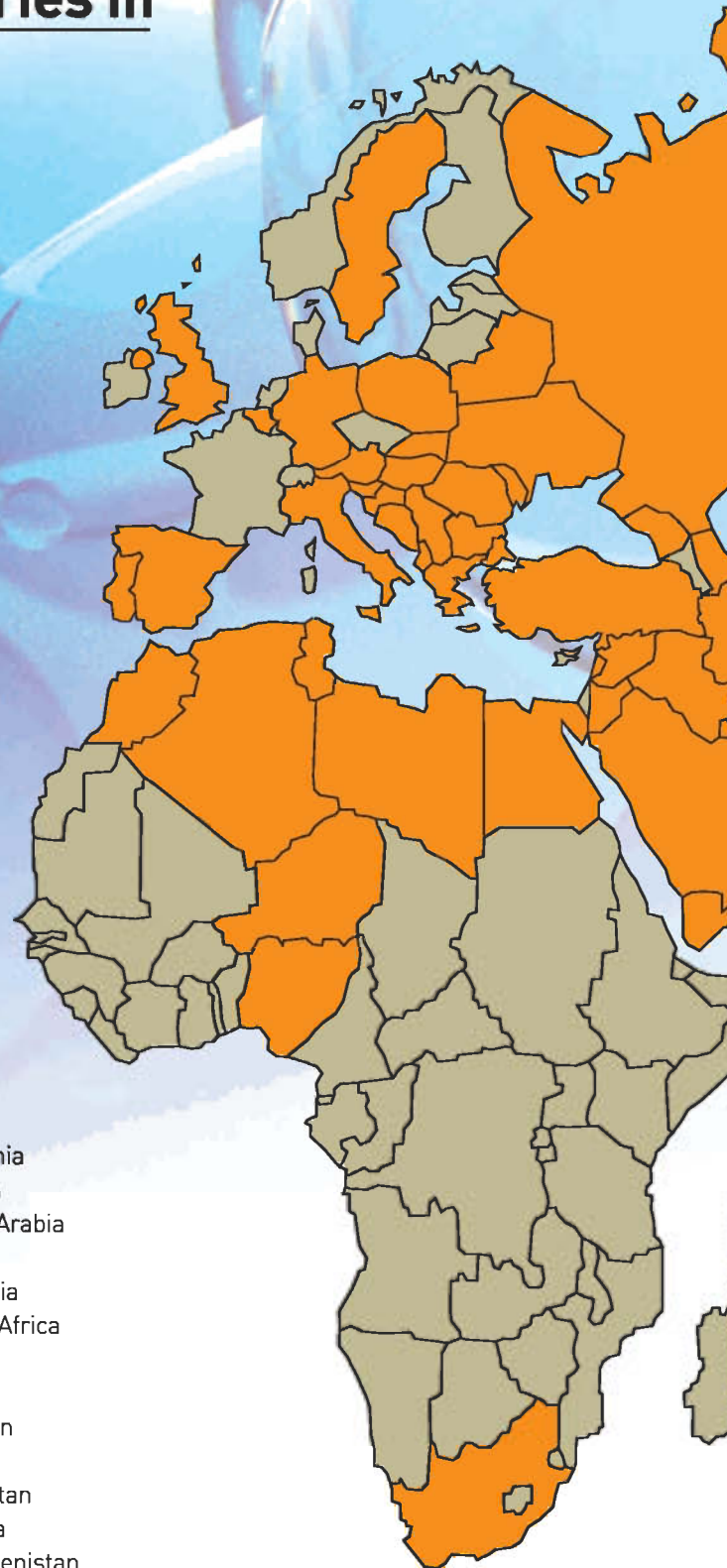

**Countries to which FIRAT exports:**

- |                        |                    |                      |
|------------------------|--------------------|----------------------|
| Afghanistan            | Iraq               | Qatar                |
| Albania                | Italy              | Romania              |
| Algeria                | Jordan             | Russia               |
| Azerbaijan             | Kazakhstan         | Saudi Arabia         |
| Bahreyn                | Kirghizstan        | Serbia               |
| Belarus                | Kosovo             | Slovenia             |
| Belgium                | Kuwait             | South Africa         |
| Bulgaria               | Lebanon            | Spain                |
| Bosnia and Herzegovina | Libya              | Sudan                |
| China                  | Macedonia          | Sweden               |
| Croatia                | Malta              | Syria                |
| Egypt                  | Moldovia           | Tajikistan           |
| England                | Morocco            | Tunisia              |
| Gambiya                | Nigeria            | Turkmenistan         |
| Georgia                | Montenegro         | Ukraine              |
| Germany                | Turkish Republic   | United Arab Emirates |
| Greece                 | of Northern Cyprus | Uzbekistan           |
| Hungary                | Pakistan           | Yemen                |
| India                  | Poland             |                      |
| Iran                   | Portugal           |                      |